



***BD Adjustable Track Bar***  
***2003-2007 Dodge Cummins 5.9L***  
***(4WD Models)***

**P/N# 1032012**

**PLEASE READ ALL INSTRUCTIONS BEFORE INSTALLATION**

## **KIT CONTENTS:**

Please check to make sure that you have all the parts listed in this kit **before** you start the disassembly your truck.

<b>1302030-1</b>	<b>1302030-2</b>	<b>1302030-4</b>
		
<i>Trackbar, Driver's Side</i>	<i>Trackbar, Passenger's Side (Left Hand Thread)</i>	<i>Threaded Connector</i>
<b>Qty: 1</b>	<b>Qty: 1</b>	<b>Qty: 1</b>
<b>1302031Z</b>	<b>1302032Z</b>	<b>1302033</b>
		
<i>Jam Nut 1 3/8NF</i>	<i>Jam Nut 1 3/8NF (Left Hand Thread)</i>	<i>Polyurethane Bushing Set</i>
<b>Qty: 1</b>	<b>Qty: 1</b>	<b>Qty: 1</b>
<b>1302057</b>	<b>1302056</b>	
		
<i>Grease Nipple (M6)</i>	<i>Grease Nipple 90° (M6)</i>	
<b>Qty: 1</b>	<b>Qty: 1</b>	

BD ENGINE BRAKE, INC.

Plant Address: A10-33733 King Rd, Abbotsford, BC, Canada V2S 7M9

US Shipping Address: 88-446 Harrison St, Sumas, WA 98295 US Mailing Address: PO Box 231, Sumas, WA 98295

Phone: 604-853-6096 Fax: 604-853-8749 Internet: [www.bd-power.com](http://www.bd-power.com)

## *Welcome*

Thank you for purchasing a BD track bar. This manual is divided into different areas to assist you with your installation and operation of your adjustable track bar.

This product is a replacement for the factory track bar. If the securing mounts have any signs of wear they should be fixed before installing the track bar. You will be reusing the factory bolts, if these bolts show any wear, replace them.

Installation should occur on a vehicle properly secured to prevent rolling.

Application of a marine grade lubricant at regular chassis lube intervals will promote bushing life.

**On 2008 vehicles Dodge upgraded the factory track bar and utilizes 16mm mounting bolts. This kit will not fit 2008 vehicles.**

## *Required Tools*

- 18mm Socket/Wrench
- 2" Open End Wrench
- Large Crescent (>1.5")
- Torque Wrench (>200 lbs-ft)
- 7mm wrench
- 9mm wrench

## *Maintenance*

Grease bushings at regular oil change intervals for optimal protection of bearing from wear and contamination due to environment. To grease use a high quality marine grade bushing grease.

BD ENGINE BRAKE, INC.

Plant Address: A10-33733 King Rd, Abbotsford, BC, Canada V2S 7M9

US Shipping Address: 88-446 Harrison St, Sumas, WA 98295 US Mailing Address: PO Box 231, Sumas, WA 98295

Phone: 604-853-6096 Fax: 604-853-8749 Internet: [www.bd-power.com](http://www.bd-power.com)

**INSTALLATION**

**VEHICLE SHOULD BE SAFELY SECURED BEFORE INSTALLATION.**

**THIS TRACK BAR SHOULD BE INSTALLED AT A SHOP THAT CAN PERFORM A FRONT END ALIGNMENT**

Lift and support front of truck. Be sure to block the wheels to prevent the vehicle from rolling.

When lifting the truck keep the suspension under tension.



Using an 18mm socket remove the driver's side track bar bolt. You will reuse this bolt for re-installation.

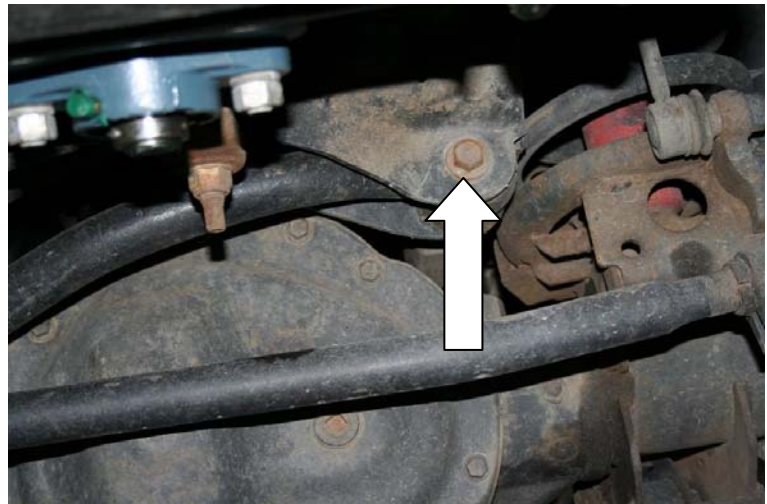
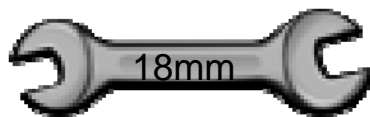

BD ENGINE BRAKE, INC.

Plant Address: A10-33733 King Rd, Abbotsford, BC, Canada V2S 7M9

US Shipping Address: 88-446 Harrison St, Sumas, WA 98295 US Mailing Address: PO Box 231, Sumas, WA 98295

Phone: 604-853-6096 Fax: 604-853-8749 Internet: [www.bd-power.com](http://www.bd-power.com)

Using the 18mm socket remove the passenger side track bar bolt. Again you will re-use for re-installation.

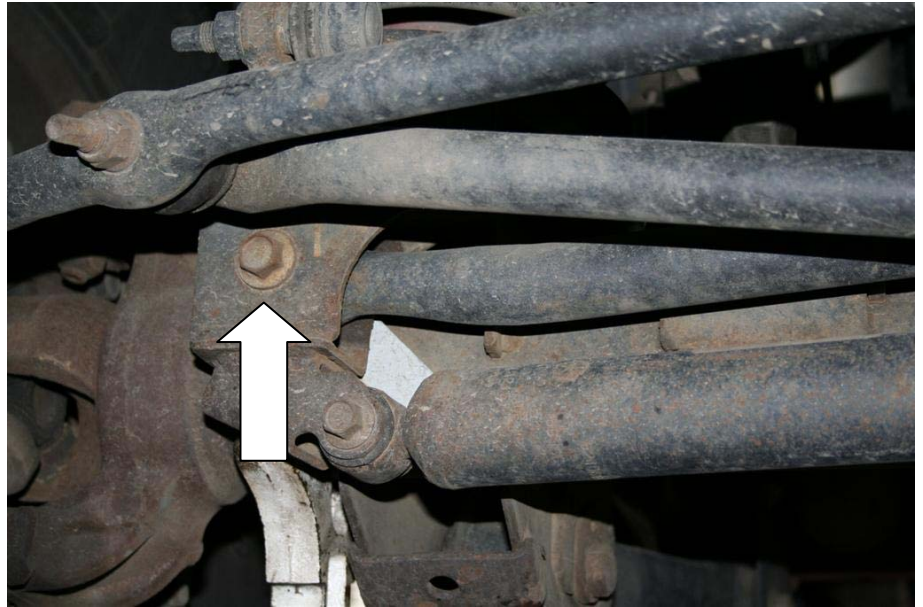
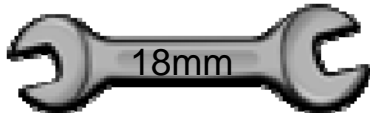

With the factory track bar removed, use a tape measure and measure the length of the factory track bar from the center of the bushing to the center of the bushing.



Locate the passenger's side track bar section (#1302030-2). Thread the 90° grease nipple (#1302056) into thread port on the side of the unit.



The grease nipple should be threaded so that the nipple face is point towards the track bar threads.

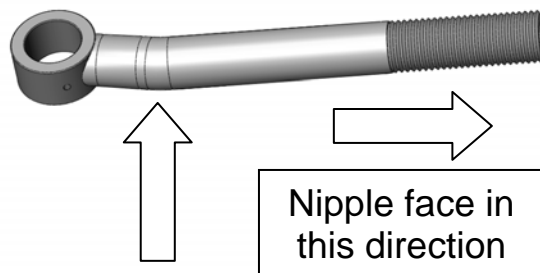

Open the bag of poly bushings (#1302033). With the supplied grease rub it all around each half of the bushing (ID and OD).

Once fully lubed press the each half of the bushing into the track bar ends.

Finally lube the steel sleeve and press into the bushings.

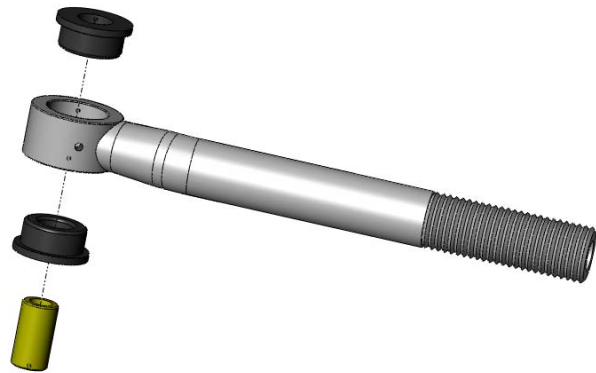

BD ENGINE BRAKE, INC.

Plant Address: A10-33733 King Rd, Abbotsford, BC, Canada V2S 7M9

US Shipping Address: 88-446 Harrison St, Sumas, WA 98295 US Mailing Address: PO Box 231, Sumas, WA 98295

Phone: 604-853-6096 Fax: 604-853-8749 Internet: [www.bd-power.com](http://www.bd-power.com)

Locate the driver's side track bar section (#1302030-1). Thread the straight grease nipple (#1302057) into thread port on the side of the unit.

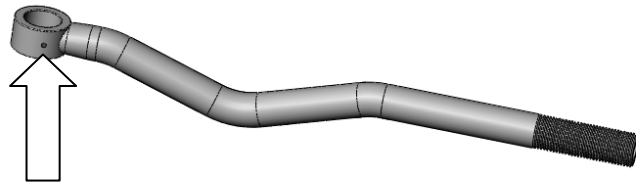

Use the remainder of the supplied grease and rub it all around each half of the bushing (ID and OD).

Once fully lubed press the each half of the bushing into the track bar ends.

Finally lube the steel sleeve and press into the bushings.

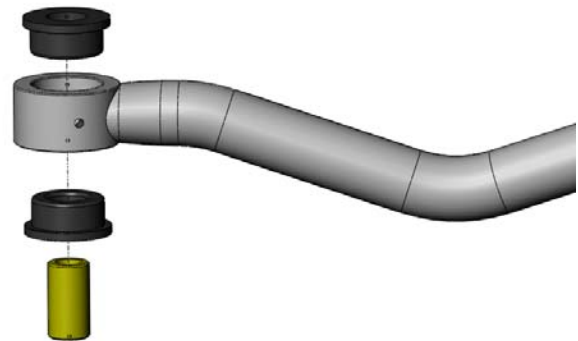

Install the Left Hand Threaded Jam nut (#1302032Z) on the passenger side track bar section. You will need to thread this all the way to the end.

The Left Hand Thread nut will have an arrow on the side face.

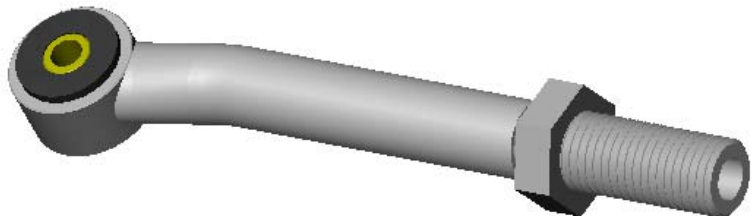

BD ENGINE BRAKE, INC.

Plant Address: A10-33733 King Rd, Abbotsford, BC, Canada V2S 7M9

US Shipping Address: 88-446 Harrison St, Sumas, WA 98295 US Mailing Address: PO Box 231, Sumas, WA 98295

Phone: 604-853-6096 Fax: 604-853-8749 Internet: [www.bd-power.com](http://www.bd-power.com)

Install a small amount of anti seize on the threads before threading the nut in place.



Install the Right Hand Threaded Jam nut (#1302031Z) on the driver's side track bar section. You will need to thread this all the way to the end.

Install a small amount of anti seize on the threads before threading the nut in place.



Thread the passenger side track bar section into the threaded connector (1302030-4).

The passenger side track bar is Left Hand threaded, so you will need to mate these threads to the left hand thread of the connector. The left handed threads should be



BD ENGINE BRAKE, INC.

Plant Address: A10-33733 King Rd, Abbotsford, BC, Canada V2S 7M9

US Shipping Address: 88-446 Harrison St, Sumas, WA 98295 US Mailing Address: PO Box 231, Sumas, WA 98295

Phone: 604-853-6096 Fax: 604-853-8749 Internet: www.bd-power.com

identified with an "LH".

Thread the driver's side section of the track bar into the threaded connector.

Measure from center of bushing to center of bushing and adjust the length to the original length of your factory track bar.

Make sure there is an equal number for threads show on each side of the threaded connector.

For example only, if you have  $\frac{1}{2}$ " of thread showing on the passenger side of the threaded connector you should also have  $\frac{1}{2}$ " showing on the driver's side of the threaded connector.



BD ENGINE BRAKE, INC.

Plant Address: A10-33733 King Rd, Abbotsford, BC, Canada V2S 7M9

US Shipping Address: 88-446 Harrison St, Sumas, WA 98295 US Mailing Address: PO Box 231, Sumas, WA 98295

Phone: 604-853-6096 Fax: 604-853-8749 Internet: [www.bd-power.com](http://www.bd-power.com)



**DO NOT EXPOSE MORE THAN 2" OF THREAD FROM EITHER SIDE OF THE THREADED CONNECTOR.**

Now you can install the track bar into the truck. Keep in mind that you will need to reuse the factory hardware. Tighten bolts to 150 ft lbs of torque.

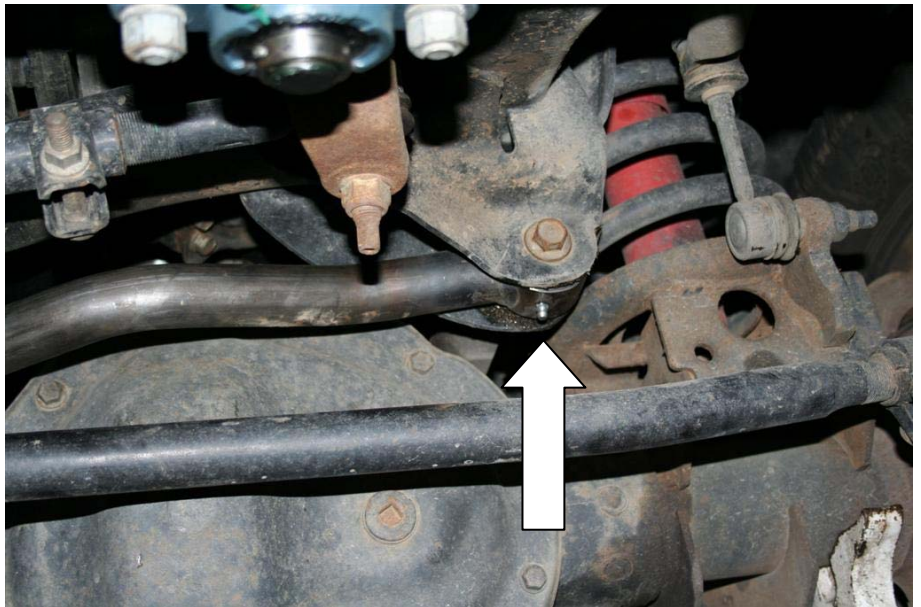
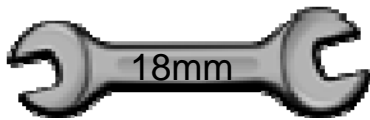

BD ENGINE BRAKE, INC.

Plant Address: A10-33733 King Rd, Abbotsford, BC, Canada V2S 7M9

US Shipping Address: 88-446 Harrison St, Sumas, WA 98295 US Mailing Address: PO Box 231, Sumas, WA 98295

Phone: 604-853-6096 Fax: 604-853-8749 Internet: [www.bd-power.com](http://www.bd-power.com)

You can now perform an alignment on the front end of the vehicle. Adjust the front axle left and right by turning the threaded connector.

The shorter you make the track bar the more it will pull the front axle towards the driver's side. And vice versa.

Once the alignment is complete tighten the jam nuts to approximately 225 ft lbs of torque.



**DO NOT DRIVE THE VEHICLE WITHOUT COMPLETING A PROPER ALIGNMENT.**

If you have any technical difficulties, concerns, comments, or complaints, please phone our Technical Support hotline at (800) 887-5030 between 8:30am-5:00pm PST (Pacific Standard Time) Monday to Friday, or post a message on the BD Discussion Forums located at:

<http://forum.bd-power.com/>



Visit our Internet forums at <http://www.dieselpower.com> and share your comments or technical support questions with some of the industry's leading experts in the diesel field.

BD ENGINE BRAKE, INC.

Plant Address: A10-33733 King Rd, Abbotsford, BC, Canada V2S 7M9

US Shipping Address: 88-446 Harrison St, Sumas, WA 98295 US Mailing Address: PO Box 231, Sumas, WA 98295

Phone: 604-853-6096 Fax: 604-853-8749 Internet: [www.bd-power.com](http://www.bd-power.com)

**LIMITED WARRANTY STATEMENT**

BD Engine Brake, Inc., Valley Fuel Injection Ltd., BD Diesel Performance, Turbocharger.net (the "Seller") warrants the following product(s):

All products manufactured or rebuilt by the Seller are to be free from defects in material or workmanship which includes but is not limited to Turbochargers, Exhaust and Intake manifolds, Exhaust brakes, Intercoolers, Flex Plates, Transmissions, Torque Converters, Oil pans, Fuel pumps and systems, Electronic monitors and control systems. The Seller warrants to the original buyer of the product (the "Buyer") that it will repair or replace, free of charge, any product which has a defect in material or workmanship within the warranty period described below.

A defect is defined as a condition within the product that would render the product inoperable under normal conditions of use and service. The Seller's responsibility under this Warranty is limited to the repair or replacement, at the Seller's option, of any warrantable product returned prepaid with a complete service history and proof of purchase. A valid proof of purchase is a dated bill of sale or receipt.

A Return Material Authorization (RMA) number, obtained in advance from a customer service representative of the Seller and the dated bill of sale or receipt, must accompany any product returned by the Buyer for warranty determination. The Seller will be the final authority on the approval of all warranty claims hereunder. The issuance of a RMA number does not represent an approval of a warranty claim. All repaired or replaced products will be returned to the Buyer freight collect. Accepted warranty products, which have been replaced, will become the sole property of the Seller.

Until the Seller has approved a warranty claim, the Buyer will be responsible for all costs. Replacement parts and the labor costs incurred by the removal and replacement of the product while performing warranty work will be the responsibility of the Buyer. In no case does the obligation of the Seller exceed the original purchase price of the product as indicated on the original bill of sale or receipt. Under no circumstances will the Seller be liable for any travel time incurred in diagnosis for defects, or any other contingent expenses.

Once the claim is approved Labor costs incurred will be considered for the removal and replacement of a eligible part while performing warranty work, at a rate of 55.00 per hour at authorized centers with prior approval of the Seller. Freight is FOB Abbotsford, B.C. Canada.

To the extent permitted by law, the Buyer hereby waives all rights other than those expressly set out herein and acknowledges that this warranty sets out the Buyer's exclusive remedies with respect to products covered by it. This warranty shall not be extended, amended or varied except by written instrument signed by the Seller and the Buyer.

The Seller will administer warranty requests on products sold by the Seller and not manufactured by the Seller by forwarding claims made by a Buyer under the manufacturer's warranty to the manufacturer. The final disposition of such claims will be made by the manufacturer and ruled by the laws of British Columbia, Canada.

BD ENGINE BRAKE, INC.

Plant Address: A10-33733 King Rd, Abbotsford, BC, Canada V2S 7M9

US Shipping Address: 88-446 Harrison St, Sumas, WA 98295 US Mailing Address: PO Box 231, Sumas, WA 98295

Phone: 604-853-6096 Fax: 604-853-8749 Internet: www.bd-power.com

**NOT COVERED UNDER THIS WARRANTY**

This warranty is limited to the original purchaser of the product and is not transferable to subsequent owners. Specifically excluded from this warranty are failures of products caused by misuse (transmissions are limited to 400RWHP), misapplication, negligence of the Buyer, accidents, modification, abuse, improper storage, installation, repair or operation, use of unauthorized parts or other mistreatment of the Buyer or his agent. This warranty does not cover deterioration of plating, paint or any other coating or parts that are subject to normal wear and tear, such as light bulbs, fuses, bearing wear, seal wear, etc.

Except as set forth herein or in our parts outline, the Seller disclaims any implied warranties of merchantability and fitness for a particular purpose. The Seller also disclaims any liability for incidental or consequential damages including but not limited to, repair labor, rental vehicles, hotel cost or any other inconvenience cost. To the extent permitted by law, this warranty is in lieu of all other warranties or guaranties, either expressed or implied, included the implied warranties of merchantability and fitness for a particular purpose and shall not extend to any Buyer or to any person other than the original purchaser residing within the boundaries of the continental U.S. or Canada. As well the seller is not responsible or obligated to updated previously manufactured parts that are currently under the above warranty.

IN THE EVENT THE BUYER DOES NOT AGREE WITH THIS AGREEMENT OR IS NOT SASTISFIED WITH THE PRODUCT, THE BUYER MAY PROMPTLY RETURN THIS PRODUCT, WITH A DATED PROOF OF PURCHASE, TO THE PLACE OF PURCHASE WITHIN THIRTY (30) DAYS FROM DATE OF PURCHASE FOR A FULL PARTS REFUND. THE SELLER OR INSTALLER IS NOT RESPONSIBLE FOR INCIDENTAL CHARGES SUCH AS OUTGOING OR INCOMING FREIGHT, RE & RE LABOR OR ANY OTHER COSTS IN RELATION TO THE PRODUCT. NOTE THAT THIS GUARANTEE WILL BE VOID IF THE USER BREACHES THE CONDITIONS IN THE SECTION LABELED "NOT COVERED UNDER THIS WARRANTY" AND IS ONLY APPLICABLE ON THE PRODUCTS THE SELLER MANUFACTURES.

**DISCLAIMER OF LIABILITY**

Other than as expressly set forth herein, the Seller, together with its distributors, jobbers and dealers shall in no way be responsible for the product's proper use and service. In no event shall the Seller be liable for any special, incidental, indirect or consequential damages of any kind or nature, whether or not the Buyer was advised of the possibility of damage, arising or resulting from the use or performance of the product, and the Buyer hereby waives any and all such claims.

The Buyer acknowledges that he/she/it is not relying on the Seller's skill or judgment to select or furnish goods suitable for any particular purpose and that the Seller has no liability that will extend beyond the scope of the limited warranty contained herein, and the Buyer hereby waives all remedies or liabilities, expressed or implied, arising by operation of law or otherwise, (including, without limitation, any obligations of the Seller with respect to fitness for any particular purpose; merchantability; and special, incidental, indirect or consequential damages) or whether or not occasioned by the Seller's negligence.

The Seller disclaims any warranty and expressly disclaims any liability for personal injury or damages related to the Buyer's use of the product. The Buyer acknowledges and agrees that the disclaimer of any liability for personal injury is a material term for this Agreement and the Buyer agrees to indemnify the Seller and hold the Seller harmless from any claim related to the product and its use or performance. Under no circumstances will the Seller be liable for any damages, liabilities, costs or expenses incurred as a result of by reason of the use, performance or sale of the product, including without limitation, any damages, liabilities, costs or expenses incurred by reason of the Buyer's negligence related to those uses of the product as a result of the removal of the speed limiter.

The Seller assumes no liability regarding the improper installation or misapplication of the product. It is the installer's responsibility to check for proper installation, and, if in doubt, contact the manufacturer.

BD ENGINE BRAKE, INC.

Plant Address: A10-33733 King Rd, Abbotsford, BC, Canada V2S 7M9

US Shipping Address: 88-446 Harrison St, Sumas, WA 98295 US Mailing Address: PO Box 231, Sumas, WA 98295

Phone: 604-853-6096 Fax: 604-853-8749 Internet: www.bd-power.com

<b>Limited Warranty Details</b>			
<b>Product Name</b>	<b>Parts (Months/Miles)<sup>1</sup></b>	<b>Labour (Months/Miles)<sup>1, 2</sup></b>	<b>Notes</b>
Torque Converters (Dodge)	24/ 24,000	12/12,000	Limited to 400RWHP
Torque Converters (Ford & Allison)	12/ 12,000	12/ 12,000	Limited to 400RWHP
Transmissions	12/ 24,000	12/ 24,000	Limited to 400 RWHP
Extended Warranty Package (Transmissions & Torque Converter)	36/ 100,000	36/ 100,000	Limited to 400 RWHP
Race Transmissions	12/ 24,000	Not Eligible	
Valve / Accumulators Bodies	12/ 24,000	12/ 24,000	
Transmission Pans	12/ 24,000	Not Eligible	
Auto / Torq / Towloc's	12 / 24,000	Not Eligible	
Flex Plates	12 / 24,000	Not Eligible	
Injectors & Injection Pumps	12 / 24,000	12/ 24,000	Race Pumps 90 days parts/No labour
Tuners and Chips	Manufacturer <sup>3</sup>	Not Eligible	
X-Monitor / Cool Down Timers	12/ 24,000	Not Eligible	
Intake / Exhaust Manifolds	12/ 24,000	Not Eligible	
Exhaust Kits	24 Months	Not Eligible	Surface rust not eligible
Turbo Guards / Boost Builders / Waste Gate Kits	12/ 24,000	Not Eligible	
Intercoolers / Hoses / Clamps	12/ 24,000	Not Eligible	
Transmission Coolers	Manufacturer <sup>3</sup>	Manufacturer <sup>3</sup>	
Manual Transmission Clutches	Manufacturer <sup>3</sup>	Manufacturer <sup>3</sup>	
Short Shifters	12/ 24,000	Not Eligible	
Engine / Head Stud kits	Manufacturer <sup>3</sup>	Manufacturer <sup>3</sup>	
Engine Brakes	24/ 24,000	12/ 24,000	
Steering Stabilizers / Sway bars	12/ 24,000	Not Eligible	
Boost Coolers	Manufacturer <sup>3</sup>	Manufacturer <sup>3</sup>	
Gauges and Mounts	Manufacturer <sup>3</sup>	Manufacturer <sup>3</sup>	
Performance Turbos	12/ 12,000	Not Eligible	
MaxFlow Fuel Pumps	60/ 75,000	Not Eligible	
Auxiliary Fuel Pumps	12/ 12,000	Not Eligible	

A Return Material Authorization (RMA) number, obtained in advance from a customer service representative of the Seller and the dated bill of sale or receipt, must accompany any product returned by the Buyer for warranty determination.

<sup>1</sup> Warranty is based on whichever occurs first (Months or Mileage).

<sup>2</sup> Prior approvals must be given to qualify for labour reimbursement.

<sup>3</sup> As per Manufacturer's warranty

BD ENGINE BRAKE, INC.

Plant Address: A10-33733 King Rd, Abbotsford, BC, Canada V2S 7M9

US Shipping Address: 88-446 Harrison St, Sumas, WA 98295 US Mailing Address: PO Box 231, Sumas, WA 98295

Phone: 604-853-6096 Fax: 604-853-8749 Internet: www.bd-power.com