

# AIR AID®

## INTAKE SYSTEMS

### Installation Instructions

Part Number 300-147

2003-04 Dodge Ram 5.9L Cummins Diesel

(Note : Use P/N 300-159 For vehicles with optional "quiet hood pad")

### Packing List:

#1	720-128	Airaid Premium Filter	1
#2	KIT128FPC	Front Air Dam Panel	1
#3	KIT128RPC	Rear Air Dam Panel	1
#4	KIT928T	Airaid Intake Tube	1
#5	KIT128A	Air Filter Adapter	1
#6	KITWSTRIP02	Weather Strip 27"	1
	KIT147HP	Hardware & Instructions	1
#7	KIT6C31MXPZ	6-32x5/16" Screw	4
#8	KIT6NWSAPZ	#6 Flat Washer	4
#9	KIT6CNKEPZ	6-32 Keps Nut	4
#10	KIT25C62HCSS	1/4-20x5/8" Hex Bolt	3
#11	KIT09FWZ019	1/4" Flat Washer	3
#12	KIT10BHCP63	8-32 Button Head Screw	2
#13	KIT15FW3016	#8 Flat Washer	2
	KITBIT01	T20 Torx Bit	1

### Tools Required For Installation:

Ratchet & Extension  
Flat Blade Screwdriver  
7mm, 1/4", 7/16" Sockets  
3/32 Allen Wrench  
T20 Torx Bit

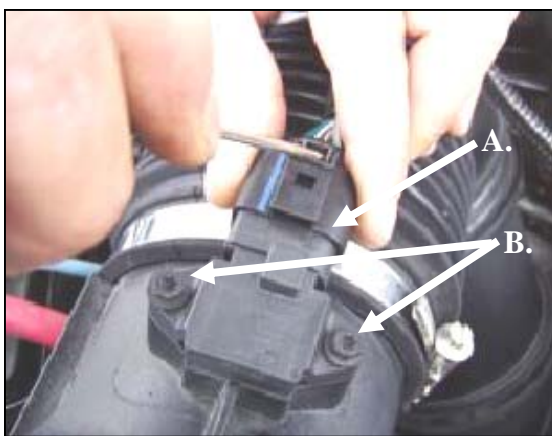
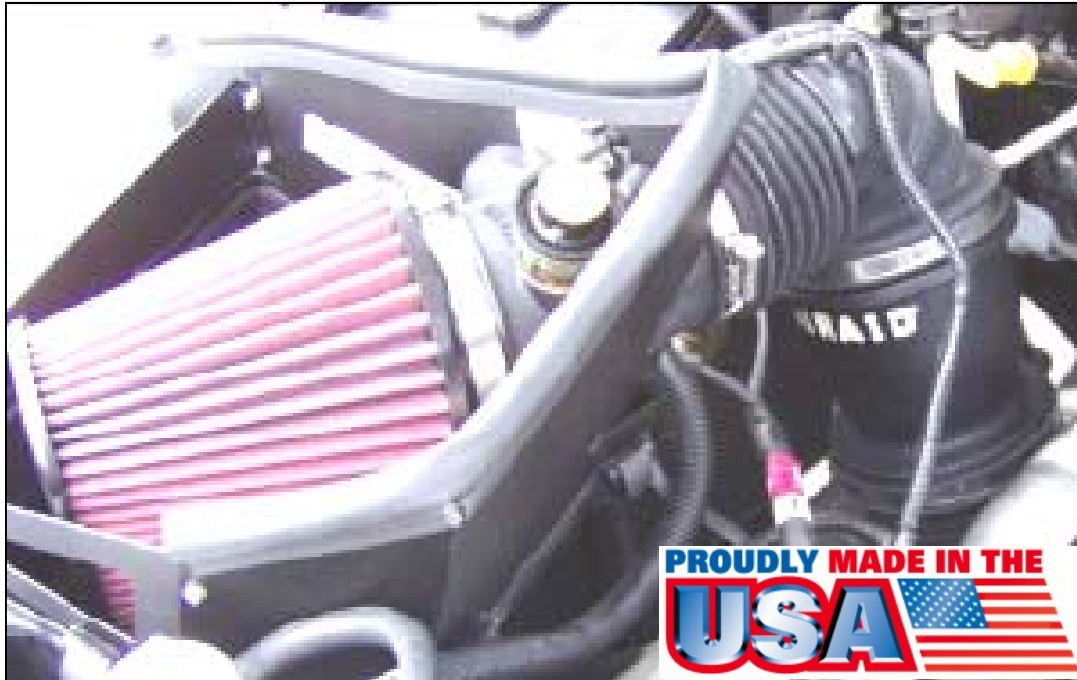

#### 1. Disconnect the negative battery cable.

A.) Disconnect the Mass Air Flow (MAF) sensor wiring harness by pushing down on the tab, and sliding the connector back.

B.) Using the provided T-20 torx bit, remove the two MAF sensor mounting bolts and the sensor from the tube (save for reuse).



2. Remove the factory filter minder and rubber grommet (save for reuse).



3. Using a 7mm socket, loosen the hose clamp where the factory intake tube connects to the turbo housing.

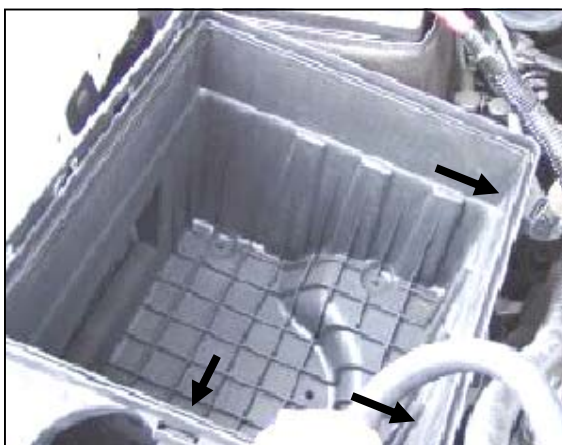

4. Unlatch the three clips on the factory air box. Remove the factory intake tube assembly and air box lid from the vehicle.

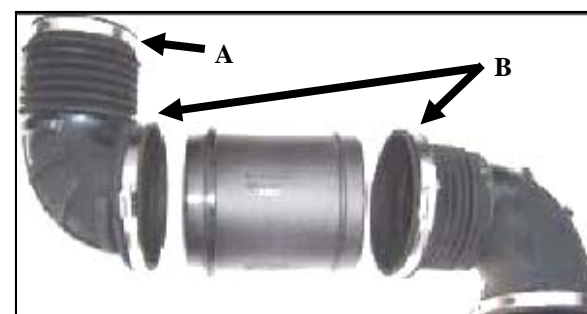

5. A.) Loosen the hose clamp that secures the factory airbox lid to the intake tube assembly, and remove the assembly from the lid.  
B.) Loosen the hose clamps above and below the factory silencer tube. Remove the factory silencer tube, and save the factory intake tubes.



6. Replace the factory silencer tube with the Airaid Intake tube (#4). Complete the Airaid Intake tube assembly by aligning the notches in the tubes, and tightening the factory hose clamps.

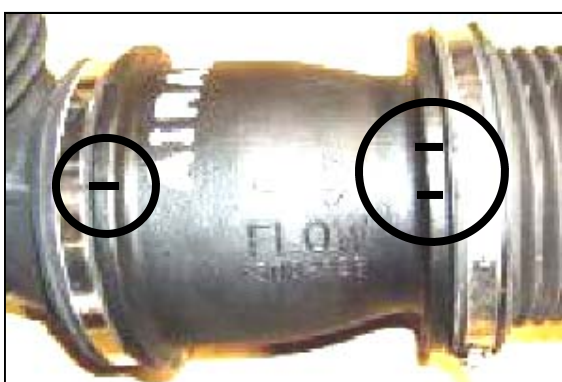

7. Note: Each side of the Airaid Intake Tube has notches that must be aligned with the notches on the factory intake tubes. Also, the flow arrow must point down toward the turbocharger inlet.



8. Install the Airaid Intake Tube assembly onto the turbocharger inlet. Tighten the factory hose clamp.



9. Assemble the Airaid Cool Air Dam (CAD) panels (#2,#3) using four 6-32x 5/16" screws (#7), #6 flat washers (#8) and 6/32 keps nuts (#9).

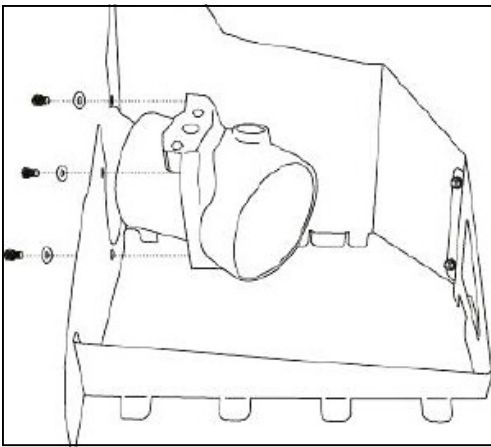

10. Mount the air filter adapter (#5) onto the CAD, using three 1/4-20x 5/8" hex bolts (#10), and three 1/4" flat washers (#11).

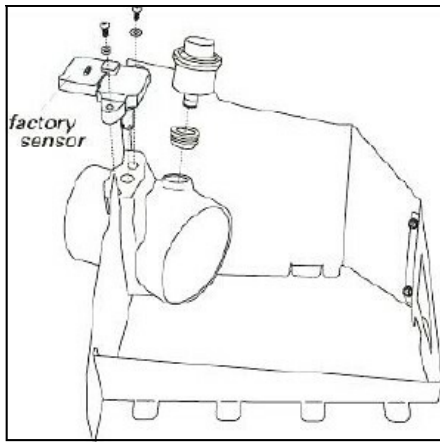

11. Install the factory MAF sensor into the air filter adapter using two 8-32 button head screws (#12), and #8 flat washers (#13). Install the factory rubber grommet and filter minder into the air filter adapter.

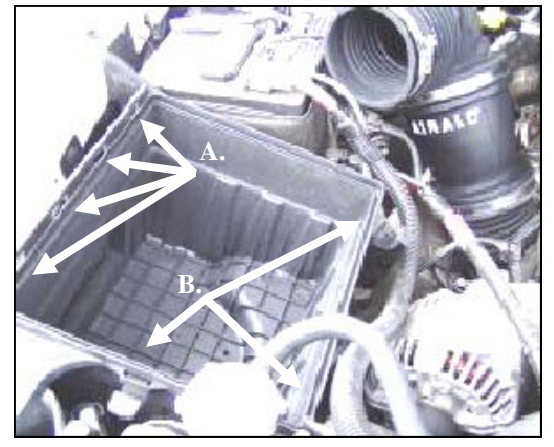

12. A.) Install the CAD by inserting the four tabs into the side of the factory airbox. B.) Relatch the three airbox clips onto the CAD.



13. Slip the intake tube onto the air filter adapter, and tighten the clamp.



14. Reconnect the MAF sensor wiring harness to the sensor.



15. Install the Airaid Premium Filter (#1) onto the air filter adapter. Install the weather strip (#6) onto the top of the CAD. (Hint: start at one end, and work to the other).

### 16. Double check your work!

Make sure there is no foreign material in the intake path. Make sure all clamps, hoses, bolts, and screws are tight.

### 17. Reconnect the negative battery cable!

Included with your Airaid Intake System is a sticker with a California Air Resources Board (C.A.R.B.) Executive Order (EO) number. This sticker must be placed in plain view inside of the engine compartment. Failure to do so may prevent you from passing a smog inspection.

Thank you for purchasing the Airaid Intake System. Contact Airaid @ (800) 498-6951 8:00 AM - 5:00 PM MST weekdays for questions regarding fit or instructions that are not clear to you. Your Airaid Intake System was carefully inspected and packaged. Check that no parts are missing, or were damaged during shipping. If any parts are missing, contact Airaid. The air filter element is protected from direct exposure to water and debris; care should be taken not to drive through deep water. WATER INGESTION IS THE DRIVERS RESPONSIBILITY! The air filter is reusable and should be cleaned using the Airaid Filter Tune-Up Kit periodically.

*Before!*



*After!*



**Don't Forget Your AIRAID Filter Tune-Up Kit!**



P/N 790-551 Aerosol Spray  
P/N 790-550 Squeeze Spray



Instructions Revision  
Date: 3/5/07