



## 2007 & UP 3" TOYOTA TUNDRA LEVELING KIT

**Thank you for choosing Rough Country for your suspension needs.**

Rough Country recommends a certified technician install this system. In addition to these instructions, professional knowledge of disassembly/reassembly procedures as well as post installation checks must be known. Attempts to install this system without this knowledge and expertise may jeopardize the integrity and/or operating safety of the vehicle.

Please read instructions before beginning installation. Check the kit hardware against the parts list on this page and the product layout on the last page. Be sure you have all needed parts and know where they go. Also please review tools needed list and make sure you have needed tools.

### PRODUCT USE INFORMATION

As a general rule, the taller a vehicle is, the easier it will roll. Seat belts and shoulder harnesses should be worn at all times. Avoid situations where a side rollover may occur.

Generally, braking performance and capability are decreased when larger/heavier tires and wheels are used. Take this into consideration while driving. Do not add, alter, or fabricate any factory or after-market parts to increase vehicle height over the intended height of the Rough Country product purchased. Mixing component brands is not recommended.

Rough Country makes no claims regarding lifting devices and excludes any and all implied claims. We will not be responsible for any product that is altered.

If questions exist about the design, function, installation, and correct use of our products please call one of our customer service representatives at 800-222-7023.

This suspension system was developed using a 305/65-18 (33" diameter) tire with factory wheels. For aftermarket wheel and tire combinations consult your tire and wheel specialist.

This kit was designed to level the front of the truck with the rear. In some cases, the vehicle owner may want the rear of the vehicle lifted also. Rough Country offers an optional 1 1/2" block and u-bolt kit is also available to raise the rear if desired.

### NOTICE TO DEALER AND VEHICLE OWNER

Any vehicle equipped with any Rough Country product should have a "Warning to Driver" decal installed on the inside of the windshield or on the vehicle's dash. The decal should act as a constant reminder for whoever is operating the vehicle of its unique handling characteristics.

**INSTALLING DEALER** - it is your responsibility to install the warning decal and forward these installation instructions on to the vehicle owner for review. These instructions should be kept in the vehicle for its service

#### KIT CONTENT:

2-Front Strut Spacers  
 2-Metal Diff Spacers  
 3-Skid Plate Spacers  
 1-Kit Bag that includes:  
   8-3/8" nut  
   8-3/8" lock washer  
   8-3/8" Self clinching bolt  
   3-8mm x 30mm Bolt  
   3-8mm Retaining Washer  
   2-9/16" x 6" bolt  
   2-9/16 Locknut  
   2-9/16 Washer

#### TOOLS NEEDED:

Hammer  
 9/16" Wrench  
 13/16" Wrench  
 10mm Wrench  
 12mm Wrench  
 14mm Wrench  
 19mm Wrench  
 22mm Wrench

#### TORQUE SPECS

Size	Grade 5	Grade 8
3/8"	30 ft/lbs	35 ft/lbs
9/16"	95 ft/lbs	130 ft/lbs
Metric		
8mm	25ft/lbs	
10mm	42 ft/lbs.	
12mm	70 ft/lbs.	
14mm	95 ft/lbs.	
16mm	200ft./lbs	
18mm	475ft./lbs	

## FRONT INSTALLATION

1. Park the vehicle on a level surface and chock the rear wheels.
2. Jack up the front of the vehicle using a floor jack. Place jack stands under the frame rails directly behind the lower control arms and lower the vehicle onto the jack stands.
3. Remove the tires and wheels.
4. Remove the sensor wire bracket as shown in **Photo 1** using a 10MM wrench, Retain the hardware for reuse.
5. Remove the upper strut nuts as shown in **Photo 2** using a 14MM wrench. Retain hardware.

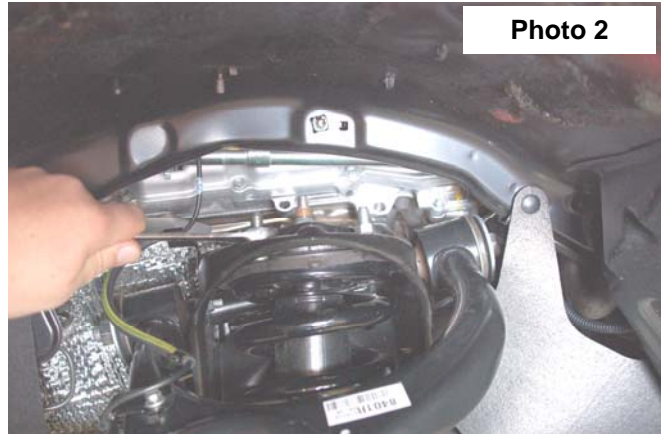

6. Remove the sway bar link from the lower control arms using a 19MM wrench. **See Photo 3.** Retain hardware.
7. Loosen , but do not remove the lower control arm bolts to allow the lower control arm to swing down using a 24MM wrench. **See Photo 4.**

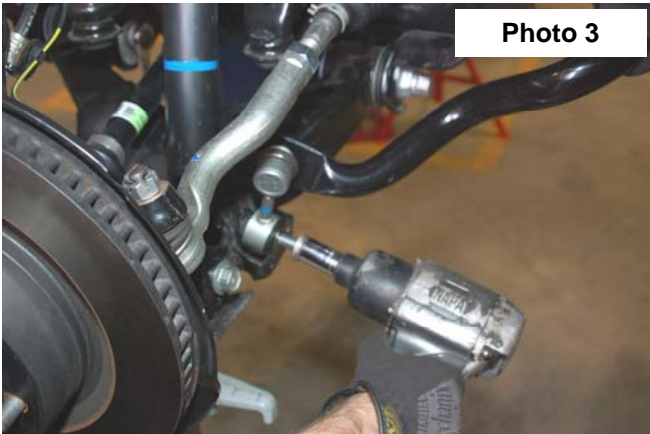

9. Remove the brake line bracket from the knuckle using a 12MM wrench.
10. Remove the upper ball joint nut using a 19MM wrench as shown in **Photo 5.** It may be necessary to hit side of the knuckle to brake the taper lock loose.
11. Remove the lower strut bolts as shown in **Photo 6** using a 22MM socket and wrench. Remove the strut from the vehicle.



12. Install the supplied 3/8" studs in the new strut spacer as shown in **Photo 7**.
13. Install the new strut spacer on the top of the factory strut using the factory hardware making sure to position the strut spacer as shown in **Photo 8** with the flat part of the spacer toward the frame rail. Tighten hardware.

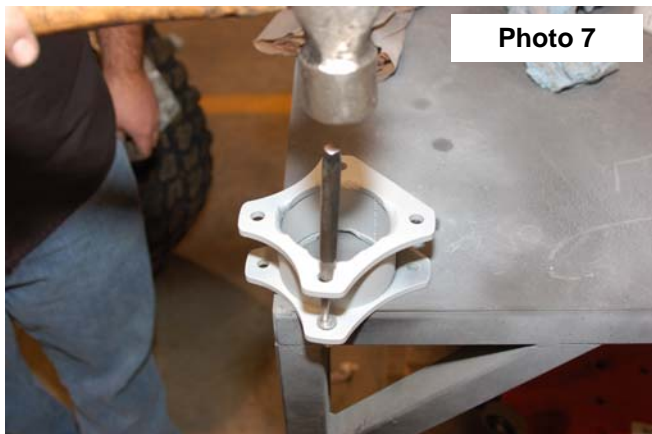

Photo 7

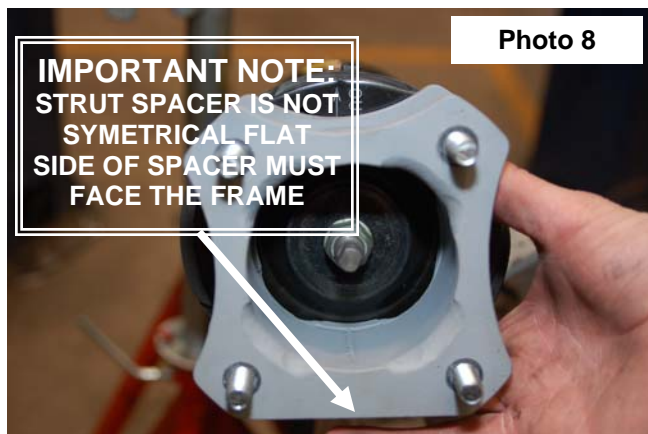

Photo 8

14. On this kit the front of the diff will be lowered to improve axle shaft angle. Remove the front driver as shown in **Photo 9** and passenger side differential bolts.
15. Install the 1" long spacers in between the diff mount and the frame with the supplied 9/16" x 6" hardware. Tighten hardware using a 13/16" wrench. **See Photo 10 & 11.**

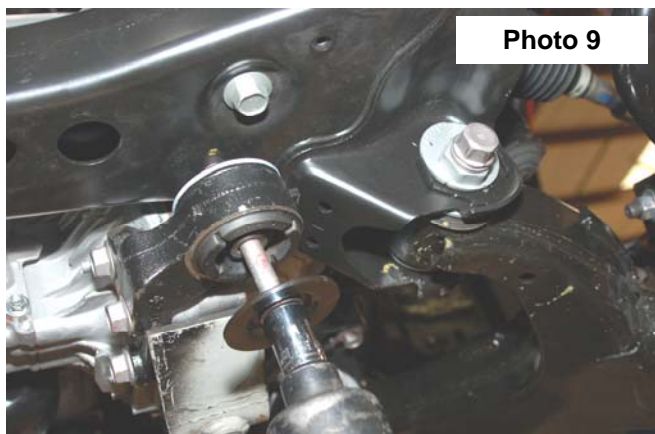

Photo 9

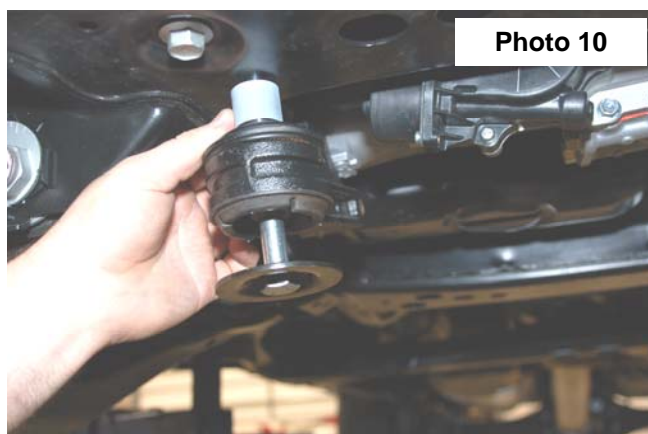

Photo 10

16. Install the strut with the spacer in the factory mount with the supplied 3/8" nuts on the upper mount and the factory hardware on the bottom. **THE STRUT SPACER IS NOT SYMETRICAL THE FLAT ON THE SPACER MUST FACE THE FRAME ON EACH SIDE.** Using a 9/16" wrench on the upper and a 22mm socket on the lower mount tighten the hardware.
17. The skid plate spacers will be placed on the skid plate. Using the 8mm x 30mm bolts supplied in the kit, place the bolts through each hole and **secure the bolts with the retaining washers a shown in Photo 12 to keep bolt and spacer in place while installing the skid plate.** Install the skid plate into the stock holes; with the spacers between the skid plate and the frame.

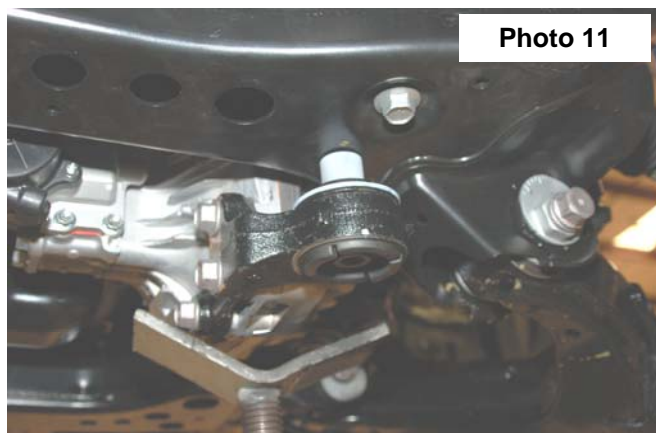

Photo 11

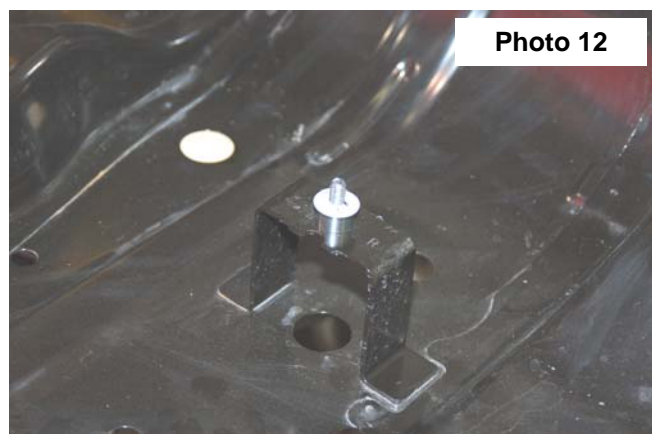

Photo 12

## POST INSTALLATION

1. Check and recheck all fasteners for proper torque. Check to ensure there is adequate clearance between all rotating, mobile, fixed and heated members. Check clearance between upper control arm and sidewall of tire for proper clearance. Check steering for interference and proper working order. Test brake system.
2. Perform steering sweep. Cycle the steering from full turn to full turn to check for clearance. Failure to perform inspections may result in component failure.
3. Re torque all fasteners after 500 miles. Visually inspect components and re torque fasteners during routine vehicle service.
4. Adjust headlights to proper settings given increased vehicle height.

## MAINTENANCE INFORMATION

It is the ultimate buyers responsibility to have all bolts/nuts checked for tightness after the first 500 miles and then every 1000 miles. Wheel alignment steering system, suspension and driveline systems must be inspected by a qualified professional mechanic at least every 3000 miles.

## KIT CONTENT:

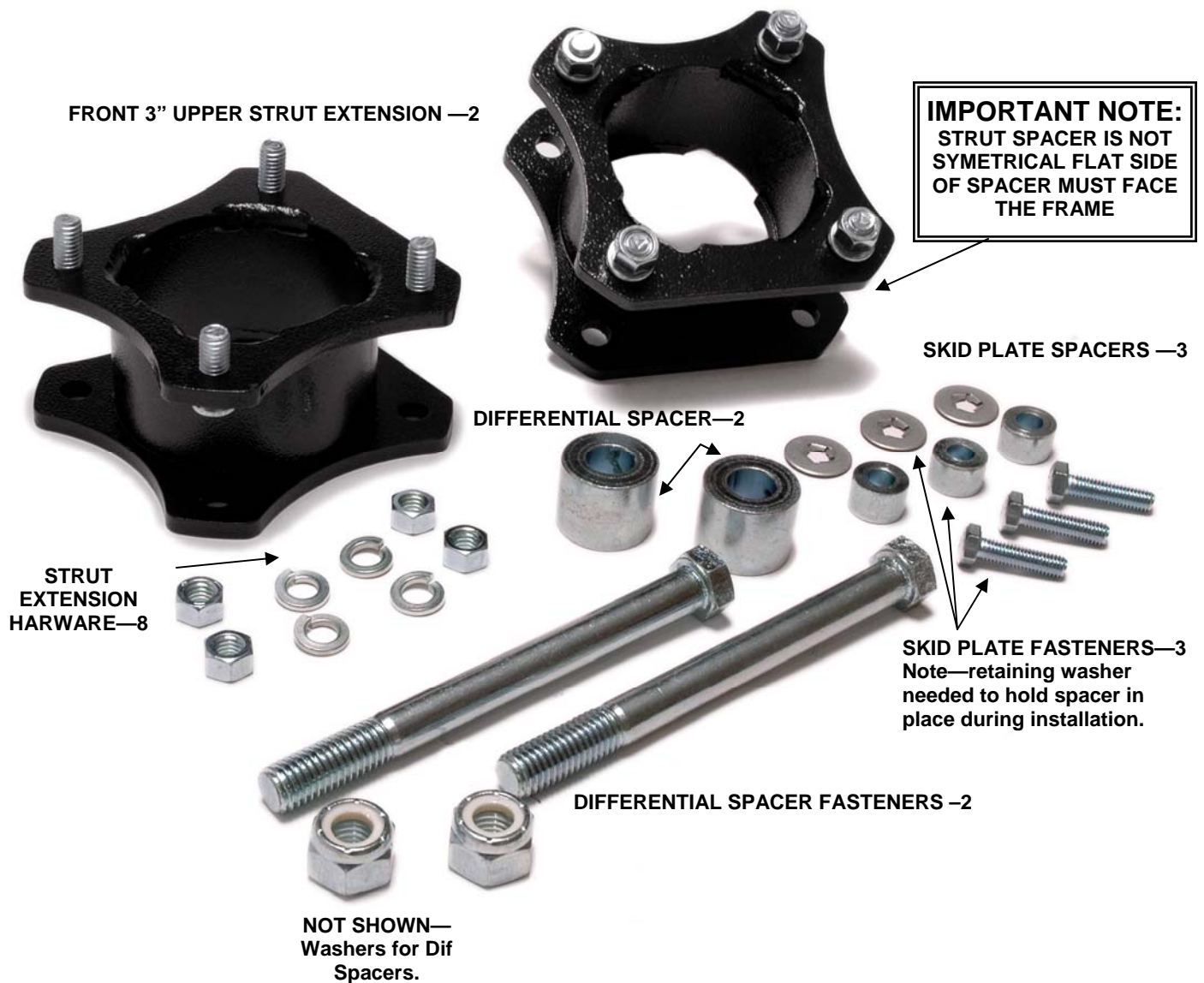

Thank you for purchasing a Rough Country Suspension System.