

**Part Number: Mounting Kit PT546-35070
Tuner Assy 86180-0W030**

NOTE: Part number of this accessory may not be the same as the part number shown.

Tuner Assy Kit Contents (86180-0W030)

Item #	Quantity Req'd.	Description
1	1	Satellite tuner assy.

Mounting Kit Contents (PT546-35070)

Item #	Quantity Req'd.	Description
1	1	Wire, to radio installation
2	1	Template
3	1	Lower receiver bracket unit
4	1	Upper receiver bracket unit
5	1	Antenna

Hardware Bag Contents-1

Item #	Quantity Req'd.	Description
1	7	Cushion tape
2	12	Lock tie

Hardware Bag Contents-2

Item #	Quantity Req'd.	Description
1	2	Flanged nut (M6)
2	4	Screws (M5 x L8)

Hardware Bag Contents-3

Item #	Quantity Req'd.	Description
1	1	Template
2	9	Sheet tape
3	1	Cushion tape
4	3	Silicone tubing (6 x 50 mm)
5	1	Silicone tubing, slit (6 x 30 mm)
6	1	Lock tie, L=150 mm
7	2	Cable rail, L=200 mm

Additional Items Required For Installation

Item #	Quantity Req'd.	Description
1		

Conflicts

--

Recommended Tools

Personal and Vehicle Protection	Notes
Safety goggles	
Seat Protectors	
Floor Protectors	

Special Tools	Notes
None	
Installation Tools	Notes
Ratchet	
Extension	
Socket	10 mm, 12 mm, 14 mm
Phillips Screwdriver	
Nylon Removal Tool	
Torque Wrench	4.1 N-m (3lbf-ft), 36 N-m (27 lbf-ft), 42 N-m (31 lbf-ft)
Side Cutter	
Drill	7 mm drill bit, drill stop
De-burring tool	
Vacuum	
Special Chemicals	Notes
Cleaner	3M™ Prepsolvent-70

General Applicability

--

Recommended Sequence of Application





Item #	Accessory

*Mandatory

Vehicle Service Parts (may be required for reassembly)

Item #	Quantity Req'd.	Description

Legend

	STOP: Damage to the vehicle may occur. Do not proceed until process has been complied with.
	OPERATOR SAFETY: Use caution to avoid risk of injury.
	CAUTION: A process that must be carefully observed in order to reduce the risk of damage to the accessory/vehicle and to ensure a quality installation.
	TOOLS & EQUIPMENT: Used in Figures calls out the specific tools and equipment recommended for this process.

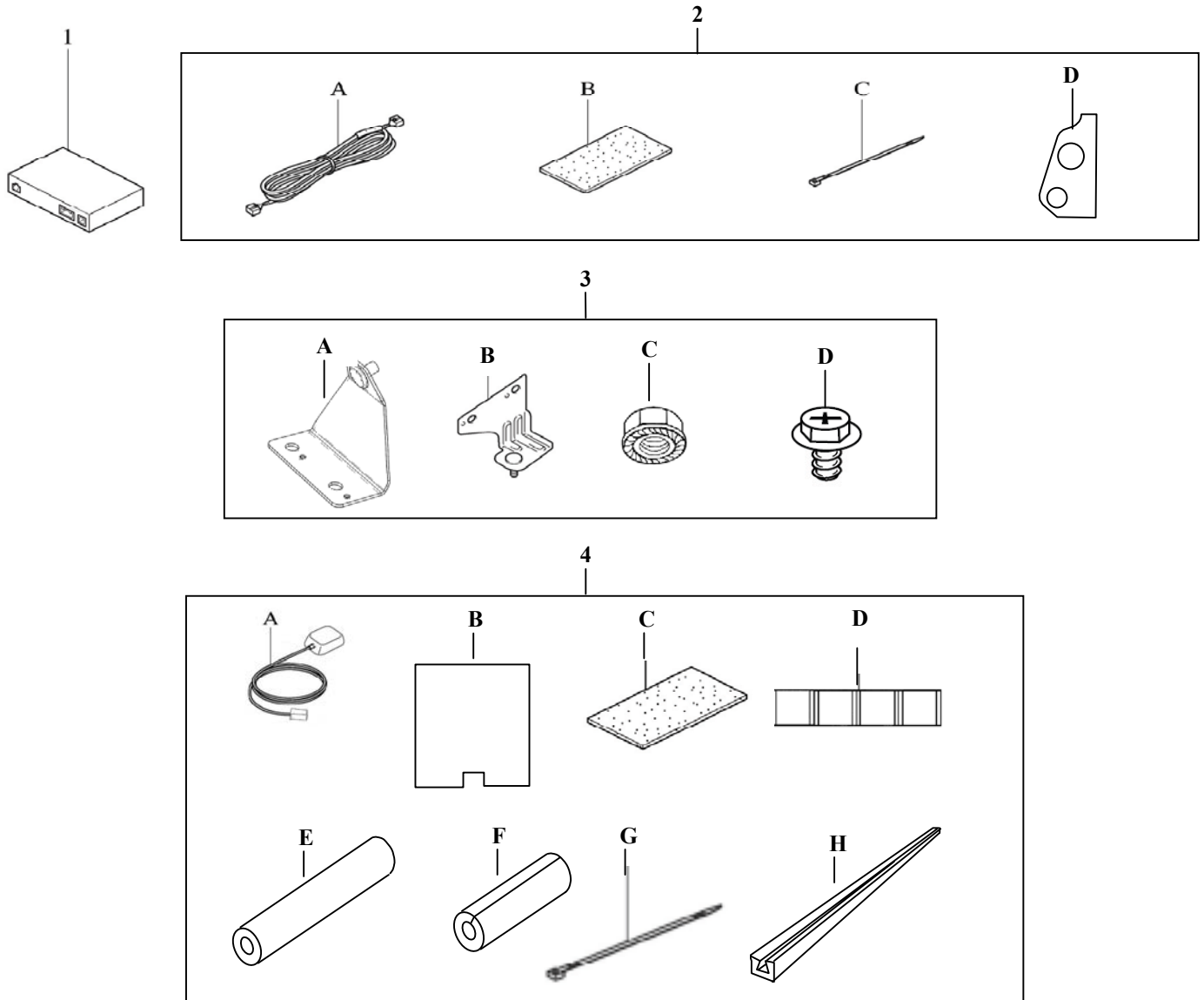

Item #	Parts Name	Qty
1	RECEIVER ASSY 86180-0W030	1
2	A RECEIVER CABLE	1
	B CUSHION TAPE	7
	C LOCK TIE	12
	D TEMPLATE (to drill rcvr. hole)	1
3	A UPPER RCVR BRACKET UNIT	1
	B LOWER RCVR BRACKET UNIT	1
	C FLANGED NUT (M6)	2
	D SCREW (M5xL8)	4
4	A ANTENNA	1
	B TEMPLATE (to locate antenna)	1
	C CUSHION TAPE	1
	D SHEET TAPE	9
	E SILICONE TUBE (50 mm)	3
	F SILICONE TUBE, SLIT (30 mm)	1
	G LOCK TIE, 150 mm	1
	H CABLE RAIL, 200 mm	2

Procedure

Care must be taken when installing this accessory to ensure damage does not occur to the vehicle. The installation of this accessory should follow approved guidelines to ensure a quality installation.

These guidelines can be found in the "Accessory Installation Practices" document.

This document covers such items as:-

- Vehicle Protection (use of covers and blankets, cleaning chemicals, etc.).
- Safety (eye protection, rechecking torque procedure, etc.).
- Vehicle Disassembly/Reassembly (panel removal, part storage, etc.).
- Electrical Component Disassembly/Reassembly (battery disconnection, connector removal, etc.).

Please see your Toyota dealer for a copy of this document.

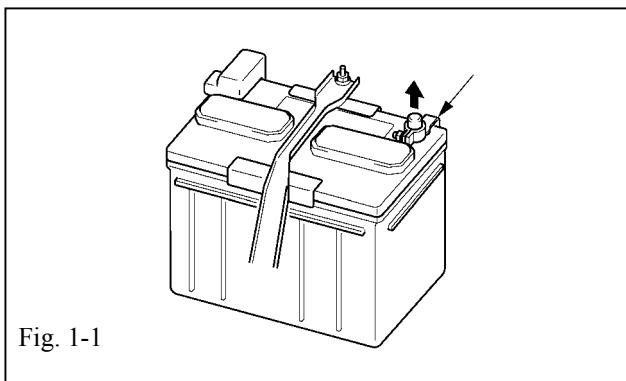



Fig. 1-1

1. Vehicle Protection.

- (a) Set parking brake.
- (b) Remove the negative battery cable (Fig. 1-1).
 -  (1) Protect the fender before starting.
 -  (2) Do not touch the positive terminal with any tool when removing cable.
- (c) Wait 90 seconds before proceeding to disassemble vehicle.

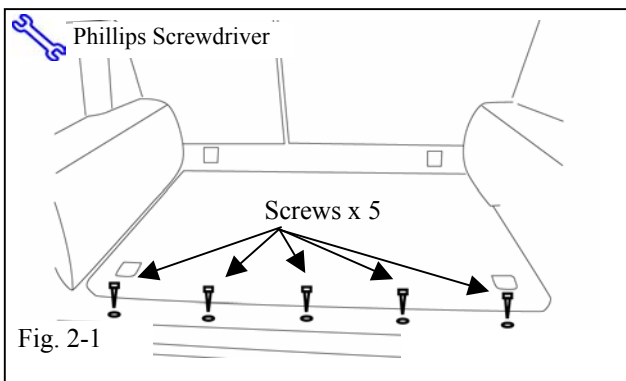



Fig. 2-1

2. Disassembly of Vehicle.

-  **NOTE:** Place all removed parts on a protected surface.
-  **NOTE:** When disconnecting wiring connectors do not pull on the wiring, pull on the connector only.

- (a) Remove the rear cargo scuff plate.
 - (1) Remove 5 screws.(Fig 2-1)
 - (2) Scuff plate is attached by plastic clips. Use nylon pry tools to lift and remove trim plate.
- (b) Remove front cargo area scuff plate
 - (1) Remove two cargo tie-downs (Fig 2-2)
 - (2) Use nylon pry tools to lift and remove scuff plate.

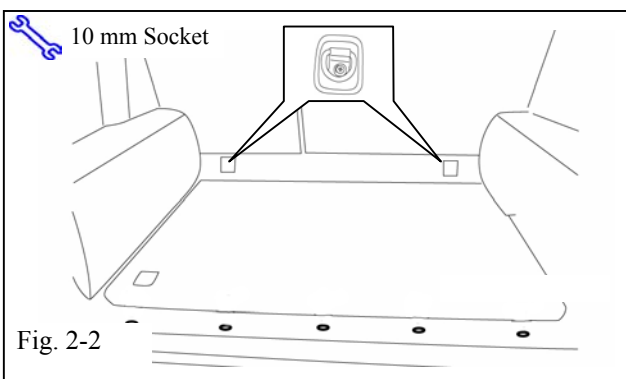
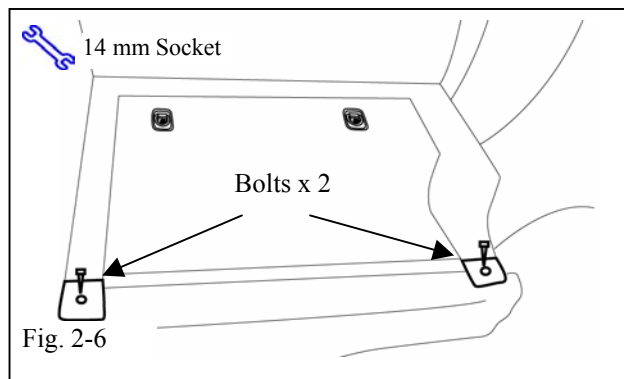
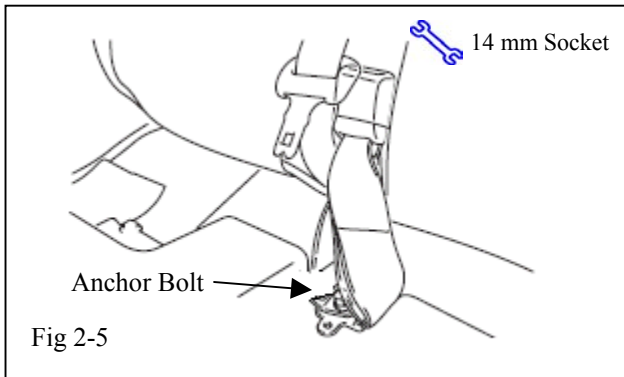
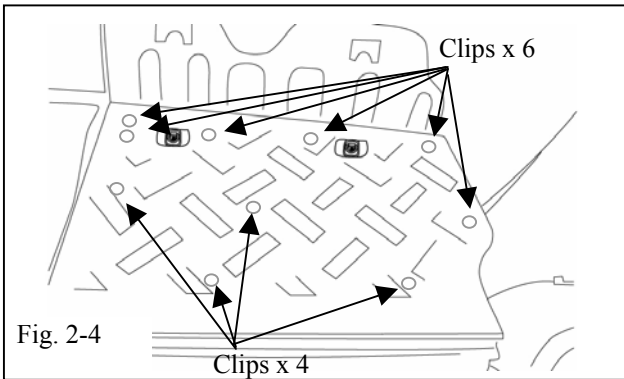
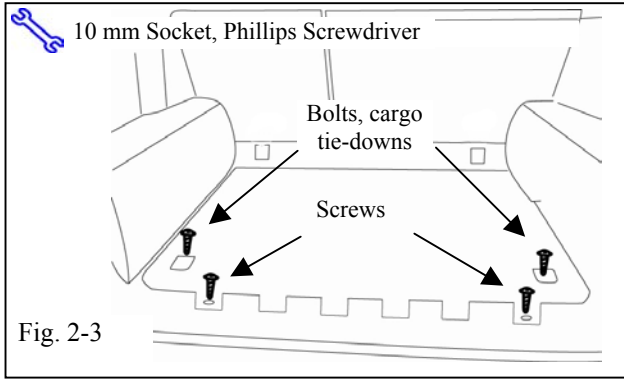
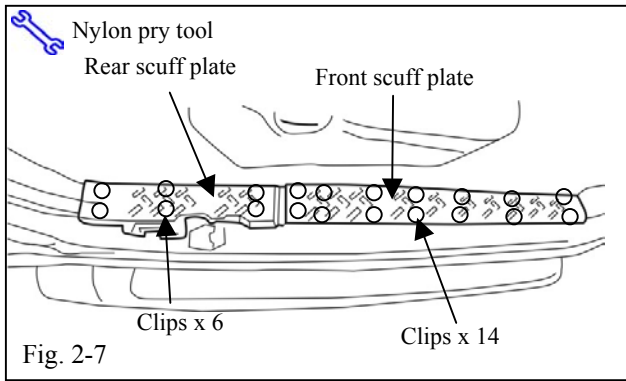

Fig. 2-2

NOTE: retain 2 fiber washers under scuff plate.



- (c) Remove the cargo mat.
 - (1) Remove the two (2) screws. (Fig. 2-3)
 - (2) Remove the two (2) bolts.
 - (3) Remove the two (2) cargo tie-downs at rear of cargo mat.
- (d) Remove the rear trim panel from the right-rear back seat.
 - (1) Flip the rear seat bottom cushion forward by lifting up on the back of the right rear seat bottom cushion.
 - (2) Fold the right rear seat-back down. Lift the knob to release seat and tilt forward.
 - (3) Remove trim panel from back of right-rear seat. Panel is held by 10 clips. (Fig 2-4)
- (e) Remove rear center seat outer belt. Remove 1 bolt and anchor plate. (Fig 2-5)
 - ⚠ Reinstallation (Seat Belt Anchor Bolt): Specified Tightening Torque: 42 N-m (31 lbf-ft)**
- (f) Remove two hex bolts from the right rear seat-back near the hinge. (Fig 2-6)
 - ⚠ Reinstallation (Seat Back Bolts): Specified Tightening Torque: 36 N-m (27 lbf-ft)**
- (g) Remove the right-rear seat-back from the vehicle.



(h) Remove the door-sill scuff plates from the right side of the vehicle.

- (1) Remove the front scuff plate by using a nylon pry tool starting from the rear. (Fig 2-7)
- (2) Remove the rear scuff plate by using a nylon pry tool starting from the rear.

NOTE: For vehicles equipped with subwoofer, remove the subwoofer assembly. For vehicles without subwoofer, skip to step (k).

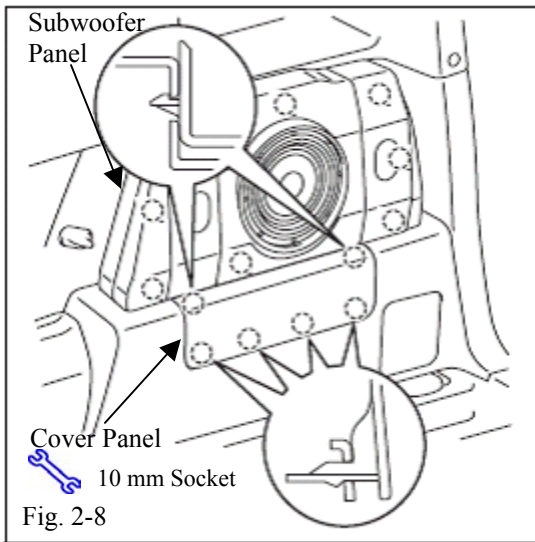

- (i) Remove the subwoofer trim panel.
 - (1) Remove the cover panel located below the subwoofer trim panel by removing the 6 clips as shown. (Fig 2-8)
 - (2) Remove the subwoofer trim panel. There are (8) plastic clips holding the trim panel. (Fig 2-8)

(j) Disconnect the subwoofer electrical connection located behind the cover panel. Remove the subwoofer housing by removing four (4) screws. (Fig 2-9)

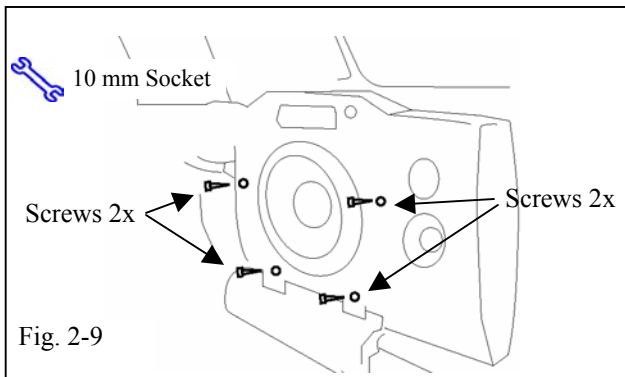

NOTE: For vehicles not equipped with a subwoofer, remove the cargo trays and cover.

- (k) Remove the right-side cargo tray. Use nylon pry tools as necessary. (Fig 2-10)
 - (1) Remove the storage box cover. (Fig 2-10)

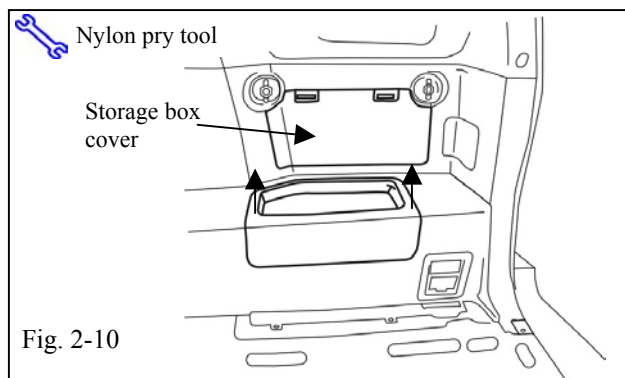

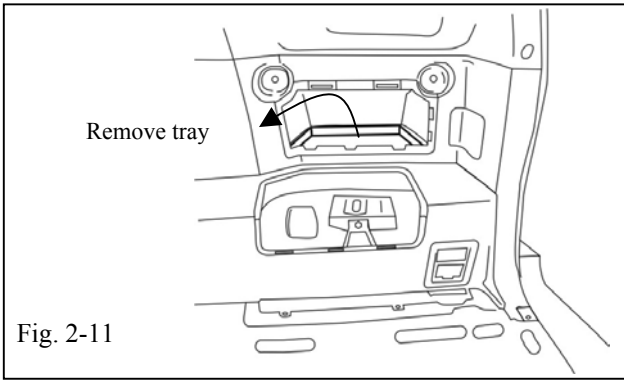

- (l) Remove the tray from the storage box.
(Fig 2-11)

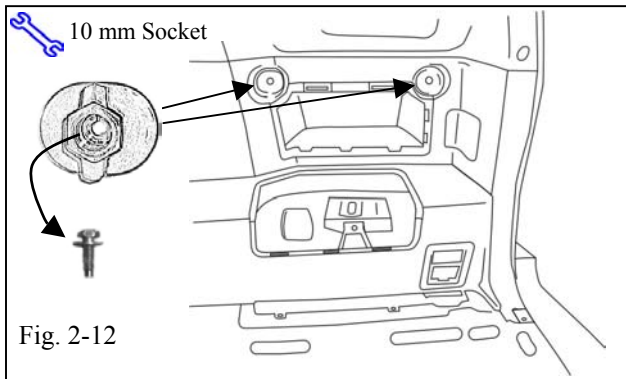

- (m) Remove the right-side lower trim panel.
 - (1) Remove the two (2) cargo hooks
(Fig 2-12)

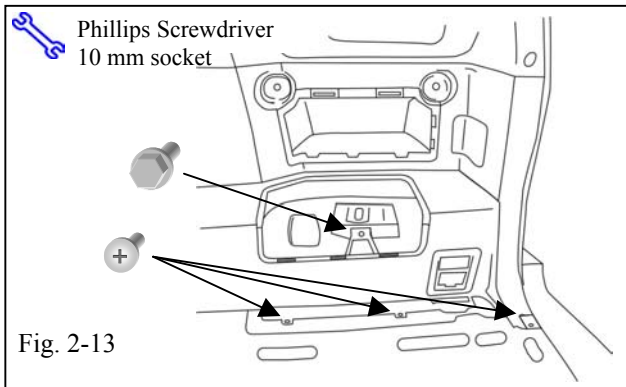

- (n) Remove one hex bolt from the panel.
(Fig 2-13)
- (o) Remove three Phillips screws from the bottom of the trim panel. (Fig. 2-13)

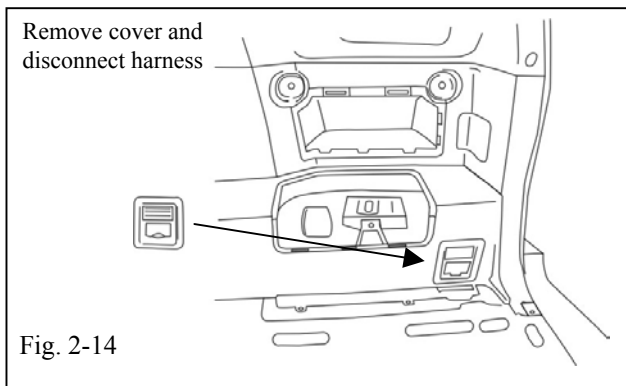

- (p) For vehicles equipped with a 115-VAC outlet, remove the small cover and disconnect the connector from the cover.
(Fig 2-14)

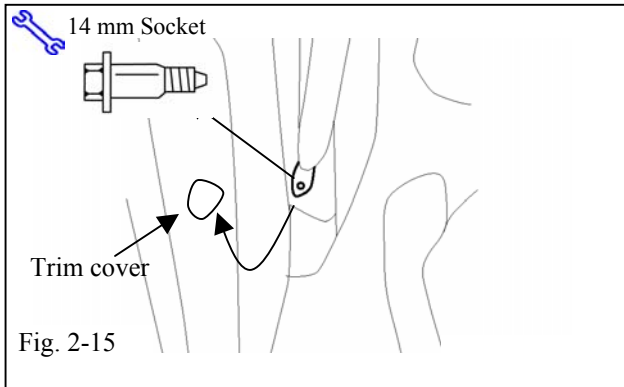

(q) Remove the trim cover from the right-rear seatbelt. (Fig 2-15)

(1) Detach the lower end of the seatbelt by removing the large bolt. (Fig 2-15)



Caution: Use protective cloth and tape to cover seat belt anchor after removal.



Reinstallation (Seat Belt Anchor Bolt): Specified Tightening Torque: 42 N-m (31 lbf-ft)

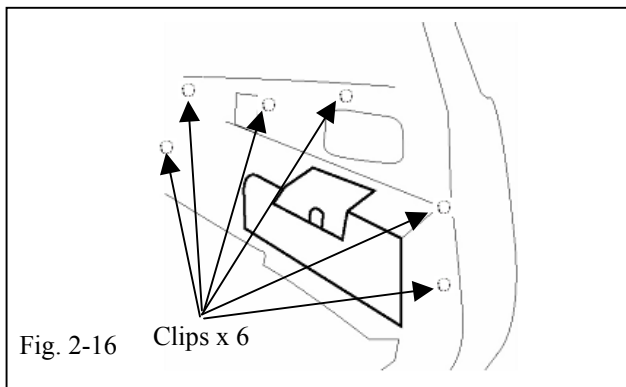

(r) Remove the lower trim panel from the vehicle. There are 6 clips around the panel perimeter holding it in place (Fig 2-16)

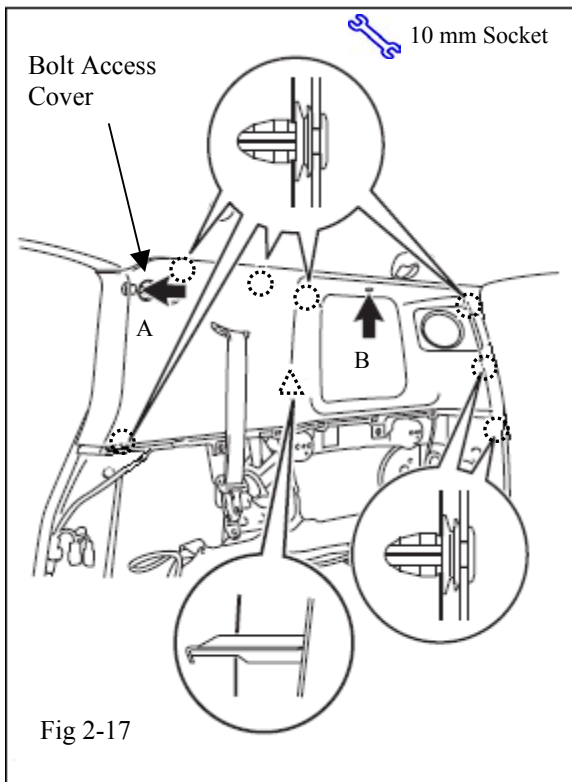

(s) Remove the upper cargo-area trim panel from the right side of the vehicle.

(1) Open the bolt access cover at the front end of the panel using a nylon pry tool. (Fig. 2-17)

(2) Remove one bolt [A]. (Fig. 2-17)

(3) Remove the plastic clip [B] in upper window by pressing in on the center button, then withdraw the clip (Fig 2-17)

(4) Remove the upper trim panel. There are 7 plastic clips and 1 claw holding it in place. (Fig 2-17)

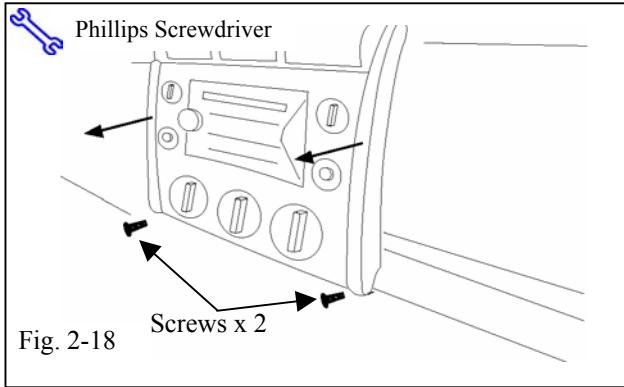

(t) Remove the radio head unit.

- (1) Remove 2 screws, one at the bottom of the trim pieces on the sides of the radio/HVAC panel. (Fig 2-18)
- (2) Gently remove the side trim pieces using the tip of a nylon pry tool as necessary.



NOTE: There are two plastic clips holding the upper end of the trim pieces. To prevent damage, remove the trim pieces by lifting upward and rearward.

(u) Remove two screws holding the HVAC/radio trim panel. (Fig 2-19)

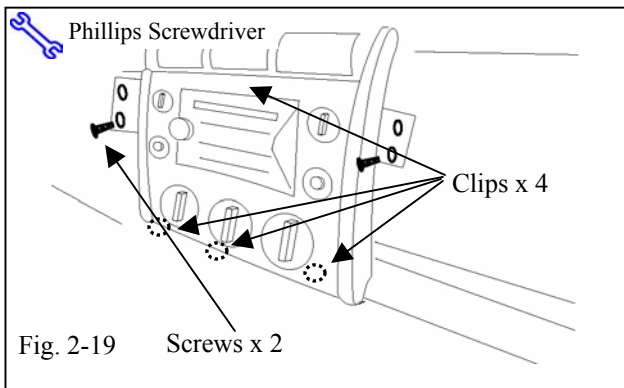

- (1) Remove the HVAC/radio trim panel. Four clips hold the panel to the IP.
- (2) Remove the electrical connectors from the trim panel.

(v) Remove the radio head unit by removing 4 hex bolts. Remove the connectors from the head unit. (Fig 2-20)

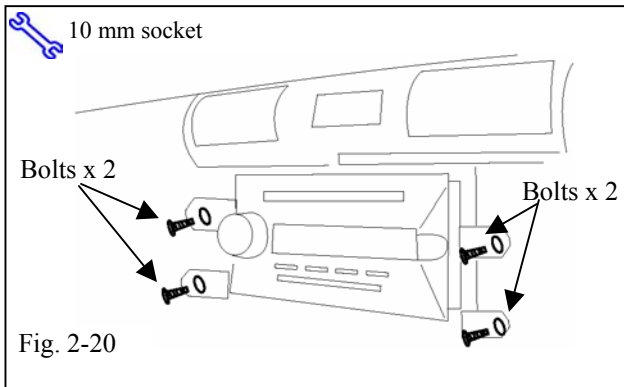

(w) Remove the glove box.

- (1) Open the glove box.
- (2) Release the damper by pulling the damper from the hinge pin (Fig 2-21)
- (3) Remove the stop on the left side of the glove box.
- (4) Pull the glove box right-side first to remove it.

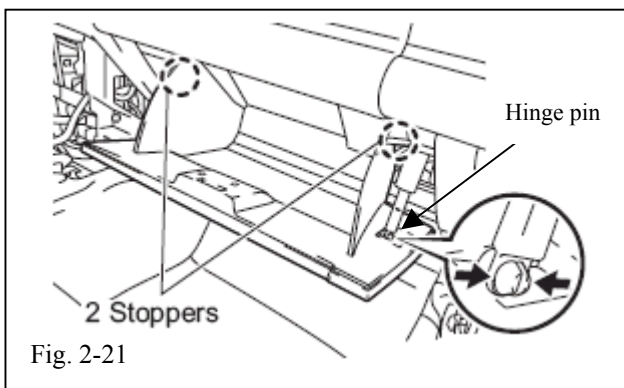

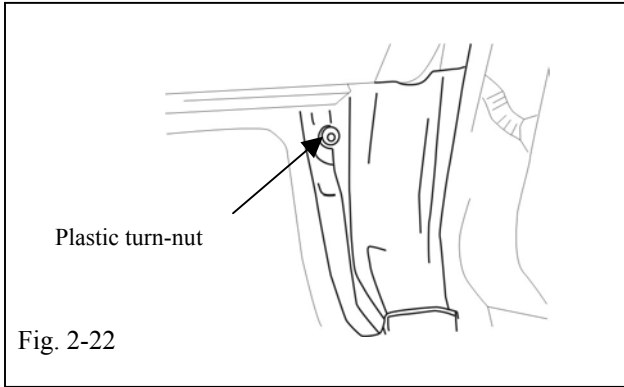

- (x) Remove the passenger side kick panel
 - (1) Remove one plastic turn-nut from the stud on the floor (Fig 2-22)
 - (2) Remove the kick panel.

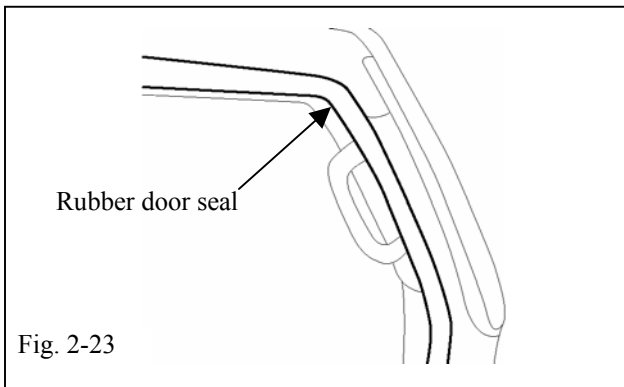

- (y) Remove the rubber door seal from the passenger door, up to the level of the dashboard top. (Fig 2-23)

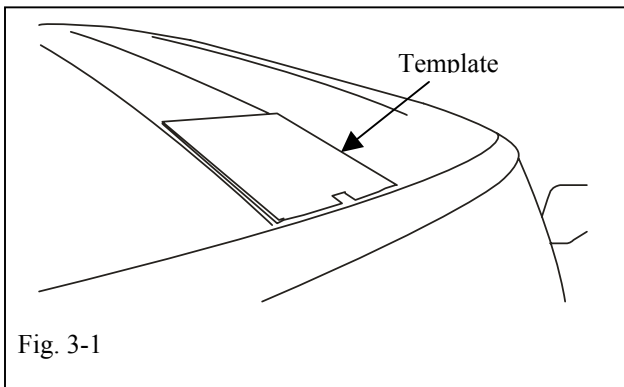

3. Install the Antenna.

- (a) Clean the antenna mounting area.
- (b) Position the antenna template on the roof as shown. (Fig 3-1) Tape the template in place.

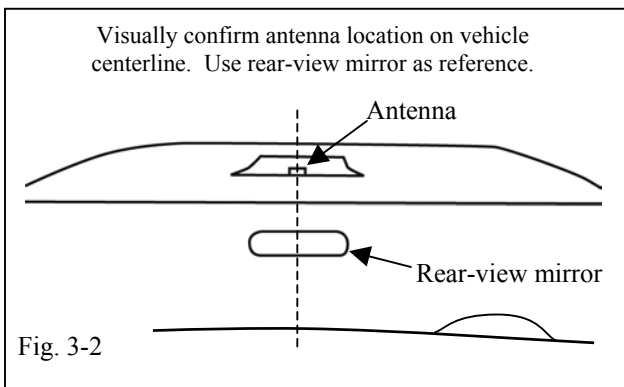

- (c) Stand in front of the vehicle and visually check the location of the antenna mounting location. (Fig 3-2) Reposition the template as necessary.

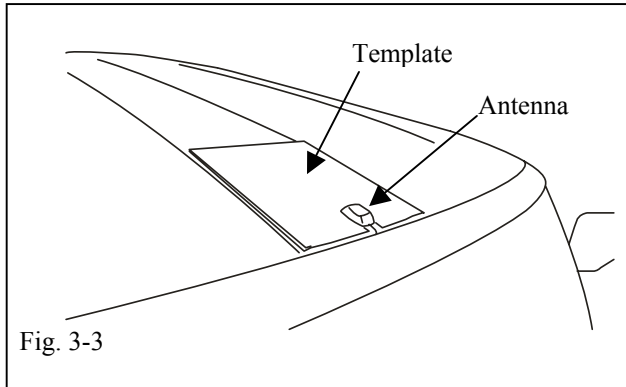

Fig. 3-3

(d) Remove the release paper from the back of the antenna. Align the antenna with the template, place the antenna on the vehicle, and press into place.

NOTE: Align the antenna with the template as shown and install it carefully. Once attached, the antenna cannot be easily removed. (Fig 3-3)

NOTE: Confirm the antenna is firmly attached by lightly lifting the antenna.

(e) Remove and discard the mounting template.

(f) Route the antenna cable as shown. (Fig 3-4)

NOTE: Tuck antenna wire under weather strip while routing around "A" pillar.

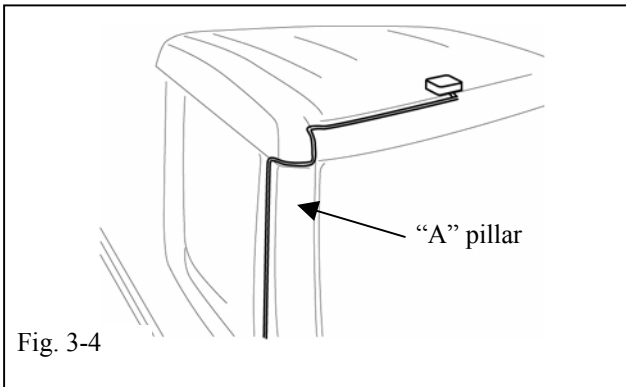

Fig. 3-4

(g) Secure the antenna wire into the gutter in 3 locations using pieces of 50- mm long silicone tubing. (Fig 3-5)

NOTE: Start from passenger side and work toward center as shown from 1 to 3. (Fig 3-5)

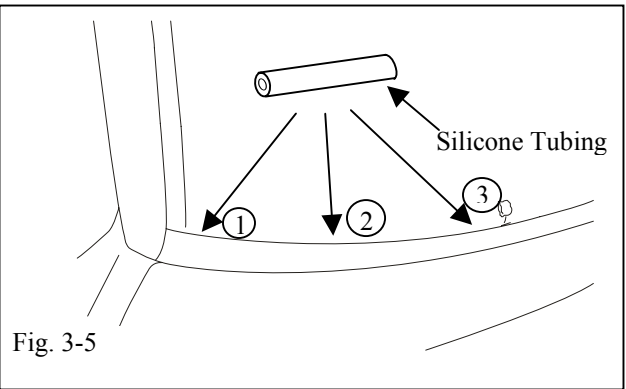

Fig. 3-5

- For a large gap (3-4 mm) use tubing as-is.
- For medium gap slit the tube lengthwise.
- For small gaps, cut the tube lengthwise and use one half.

NOTE: The size of the gap will vary by location. Cut and trim tubing as needed to achieve good retention of cable. (Fig 3-6)

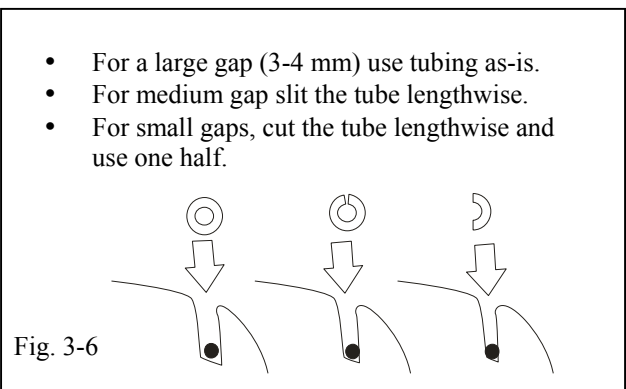
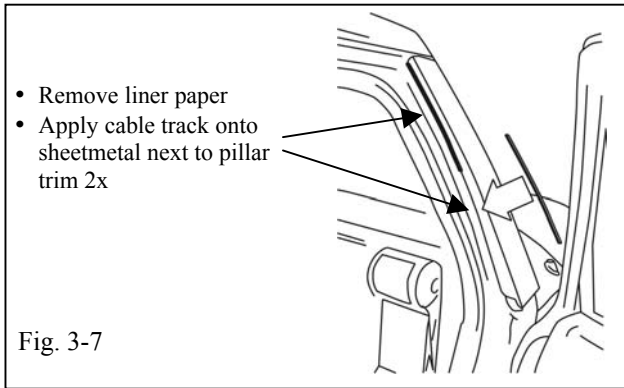

Fig. 3-6



(h) Apply two pieces of 200 mm cable track to the A pillar as shown. The lower track should be placed adjacent to the upper track (Fig 3-7)

(1) Route the cable as shown in the cable track.

⚠ NOTE: Clean cable track installation area with 3M™ Prepsolvent-70 before installation.

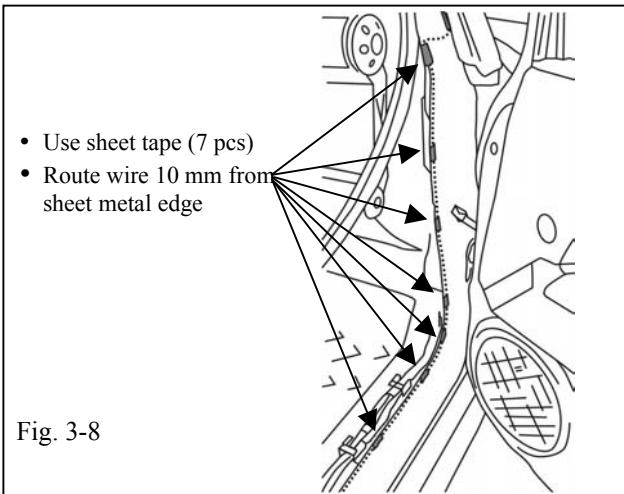

(i) Route the antenna cable as shown using 7 pieces of sheet tape (Fig 3-8)

⚠ NOTE: Clean sheet tape installation area with 3M™ Prepsolvent-70 before installation.

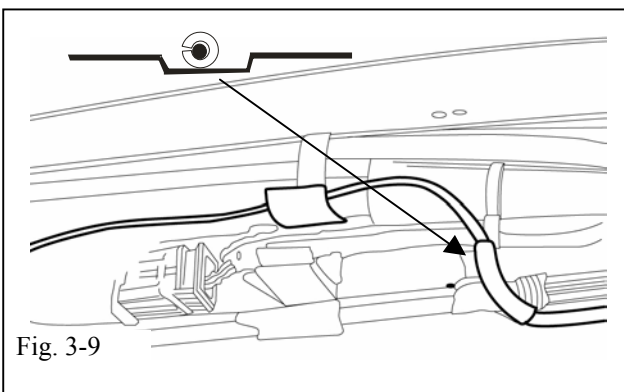

(j) Place the slit 30 mm piece of silicone tubing over the antenna cable.

(k) Route the cable in the groove in the sheet metal as shown (Fig 3-9)

⚠ NOTE: ensure that the slit is turned to the side where the cable passes over the sheet metal edge.

(l) Apply 2 pieces of sheet tape over antenna cable as shown. (Fig 3-10)

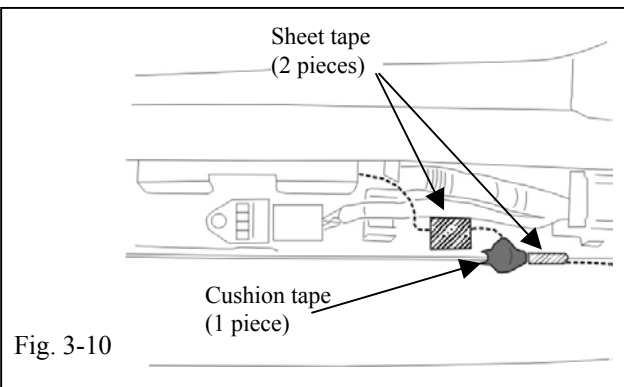

(m) Apply 1 piece of cushion tape over the cable and tubing as shown.

⚠ NOTE: Clean sheet tape / cushion tape installation area with 3M™ Prepsolvent-70 before installation.

(n) Route antenna wire along the right side harness tray as shown. (Fig 3-10) Route cable inside cable clamps.

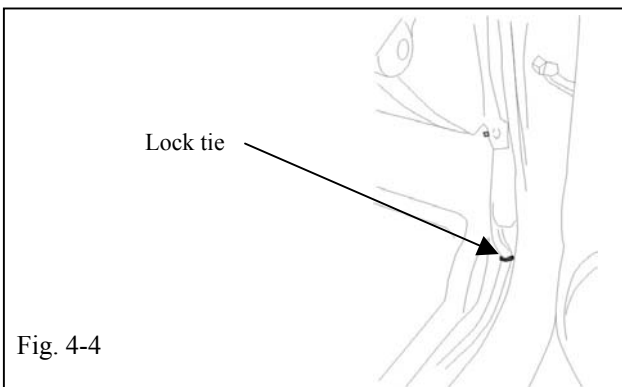
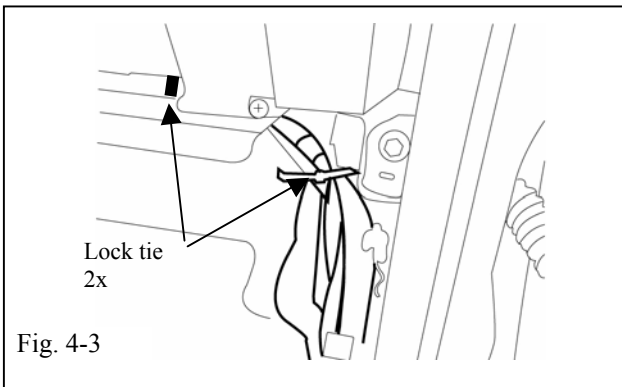
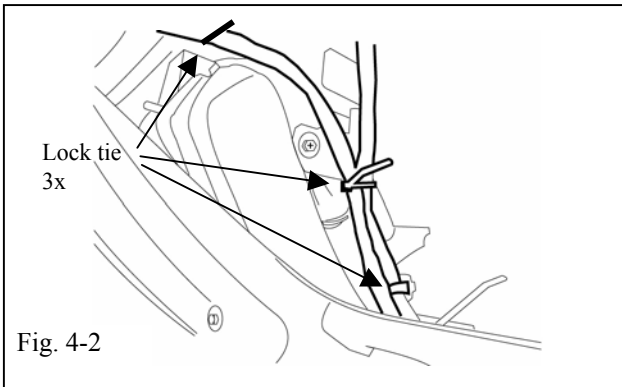
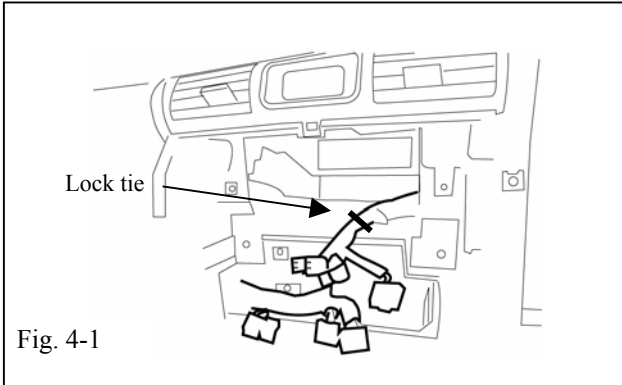

4. Install the Receiver Cable.

- (a) Attach the receiver cable to the other radio harnesses using 1 lock-tie, 150 mm from the connectors. (Fig 4-1)
- (b) Route the receiver cable around left side of glove-box opening as shown. Attach to harness using 3 lock-ties. (Fig 4-2)
- (c) Route the receiver cable along the bottom of glove-box opening. Secure to harness with 2 lock ties as shown (Fig 4-3)
- (d) Route cable along existing harness. Secure using 1 lock tie as shown (Fig 4-4)
- (e) Route cable along right side vehicle cableway, under clamps.

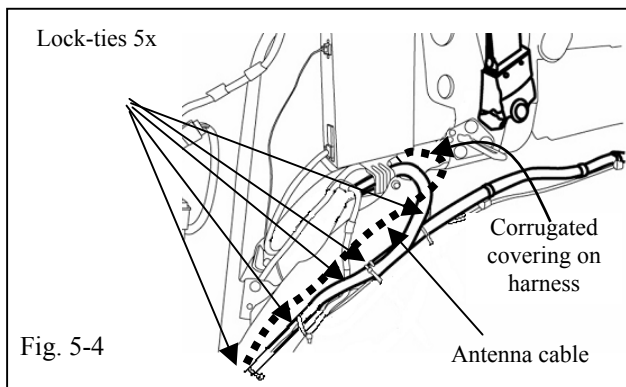
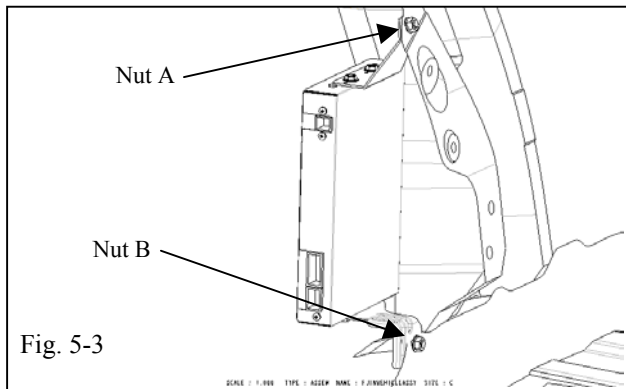
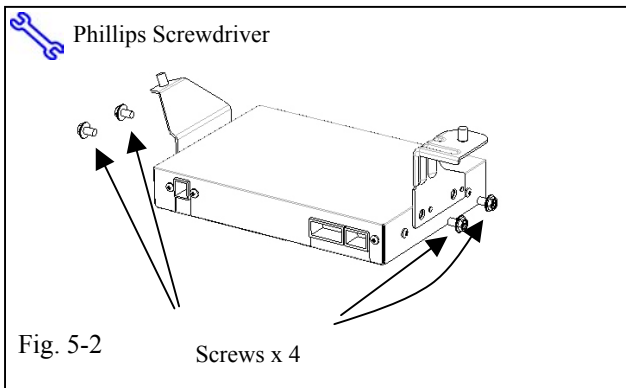
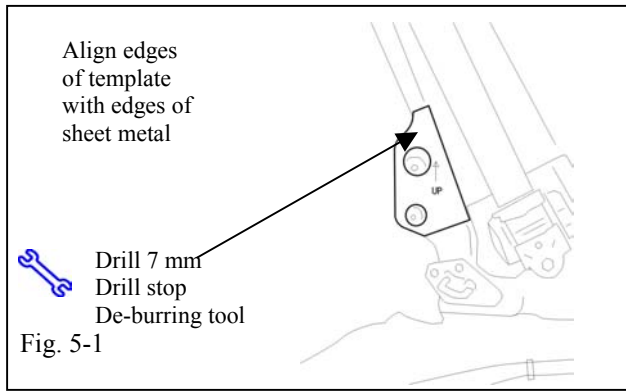

5. Install the Receiver.

- (a) Place the template as indicated on the sheet metal over the right rear wheel well (Fig 5-1.) Tape the template in place.
- (b) Mark and drill a hole 7 mm diameter as indicated by the template. A drill stop should be used set at a depth of 12.7 mm or 1/2 inch.

⚠ NOTE: De-burr hole after drilling.

NOTE: Vacuum all metal shavings before proceeding.

- (c) Install the brackets on the receiver (Fig 5-2)

- (d) Install the tuner to the body sheet metal. (Fig 5-3)

- (e) Install nut A (Fig 5-3)

- (f) Install nut B (Fig 5-3)

NOTE: When nut B is tightened, the sheet metal will deform slightly.

- (g) Use 5 lock-ties to bundle and attach tuner wire harness to existing vehicle harness. (See Fig 5-4)

- (h) Route receiver harness and antenna cable to wheel well outer as shown (Fig 5-4)

⚠ NOTE: The corrugated-tubing section of harness should be located where harness crosses sheet metal edge.

- (i) Plug antenna and receiver cables into tuner.

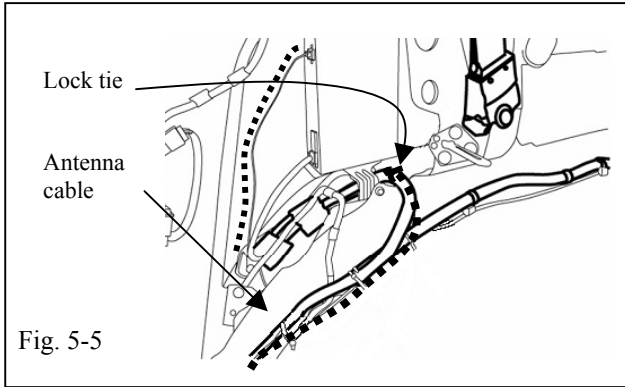

- (j) Route antenna cable with receiver cable.
Attach using 1 lock-tie as shown (Fig 5-5).

NOTE: Position the antenna cable on top side of receiver harness away from sheet metal edge.

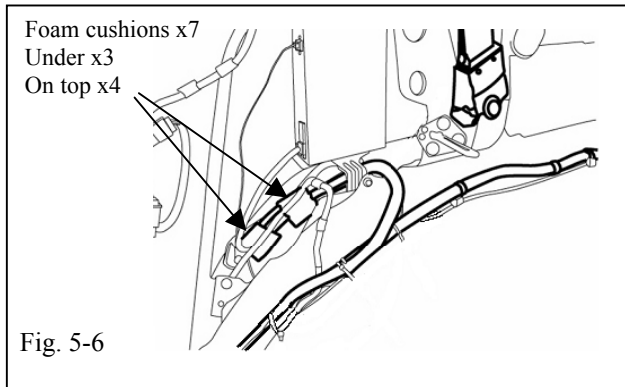

- (k) Place 3 foam cushions on the wheel well sheet metal under where the wire harness will go.
- (l) Secure excess antenna cable and excess wire harness to the wheel well using 4 foam cushions. (See Fig 5-6)

6. Completing the Installation

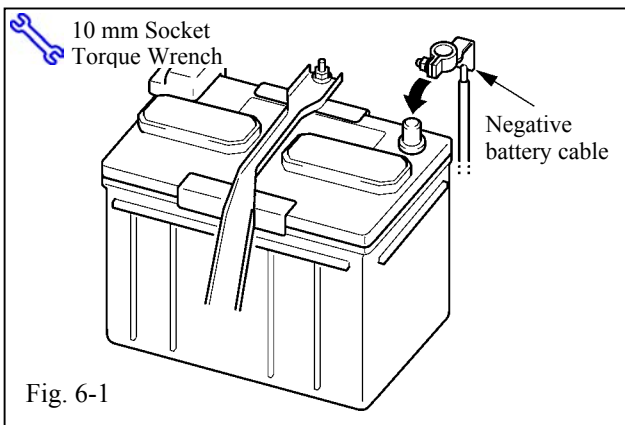

- (a) Complete the reassembly of the vehicle.
 - (1) Reconnect any disconnected connectors.
 - (2) Verify the panels fit together properly with no uneven gaps between them.
 - (3) Reinstall seat belt anchors.
 - (4) Reinstall seat back bolts.
- (b) Clean up and remove any trash.
- (c) Reconnect the vehicle's negative battery cable (Fig. 6-1).
 - (1) Position the negative terminal at original factory position.



- (2) Tighten the nut to 4.1 N-m (36 lbf-in).



- (3) Do not touch the positive terminal with any tool when replacing the cable.
- (4) Place the xM brochure in the glove box.

Check:

Look For:

Accessory Function Checks

- Verify the proper operation of the satellite radio tuner. Refer to the receiver assembly and radio owner's manuals.
- Verify the proper operation of the receiver assembly and radio. Refer to the receiver assembly and radio owner's manuals.

Vehicle Function Checks

- Verify the proper operation of the hazard switch.
- Verify the rear passenger seat back is in the upright position and the latch secured.
- Verify the proper operation of the air conditioning system.
- Verify the proper operation of the multi-information displays. (Clock, Temp., and MPG meter)
- Verify the proper operation of the subwoofer if equipped.
- Verify the proper operation of the 115VAC outlet switch.