

Symbols (Terminal No.)	Wiring Color	Terminal Description	Condition	Specified Condition
+BM2 (A5-2) - GND3 (A5-4)	L-Y - W-B	Power supply for motor from battery	Always	11 to 14 V

HINT:

- (*1): A/T
- (*2): 4WD
- (*3): with rear differential lock
- (*4): with AUTO LSD
- (*5): with A-TRAC

BC

DIAGNOSIS SYSTEM

1. CHECK DLC3

- The ECU uses ISO 15765-4 for communication. The terminal arrangement of the DLC3 complies with ISO 15031-3 and matches the ISO 15765-4 format.

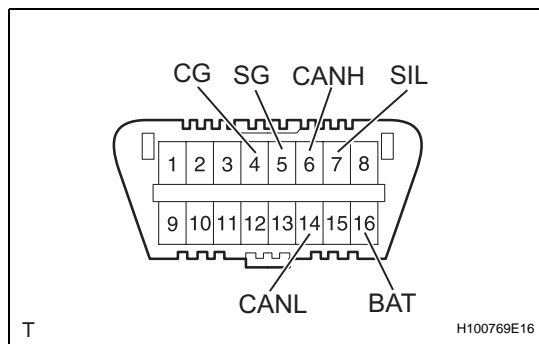

Symbols (Terminal No.)	Terminal Description	Condition	Specified Condition
SIL (7) - SG (5)	Bus "+" line	During transmission	Pulse generation
CG (4) - Body ground	Chassis ground	Always	Below 1 Ω
SG (5) - Body ground	Signal ground	Always	Below 1 Ω
BAT (16) - Body ground	Battery positive	Always	10 to 14 V
CANH (6) - CANL (14)	HIGH-level CAN bus line	Ignition switch OFF*	54 to 69 Ω
CANH (6) - CG (4)	HIGH-level CAN bus line	Ignition switch OFF*	200 Ω or more
CANL (14) - CG (4)	LOW-level CAN bus line	Ignition switch OFF*	200 Ω or more
CANH (6) - BAT (16)	HIGH-level CAN bus line	Ignition switch OFF*	6 kΩ or more
CANL (14) - BAT (16)	LOW-level CAN bus line	Ignition switch OFF*	6 kΩ or more

NOTICE:

*: Before measuring the resistance, leave the vehicle as is for at least 1 minute and do not operate the ignition switch, any other switches or the doors.

If the result is not as specified, the DLC3 may have a malfunction. Repair or replace the harness and connector.

HINT:

Connect the cable of the intelligent tester to the CAN VIM, connect the CAN VIM to the DLC3, turn the ignition switch ON and attempt to use the tester. If the display indicates that a communication error has occurred, there is a problem either with the vehicle or with the tester.

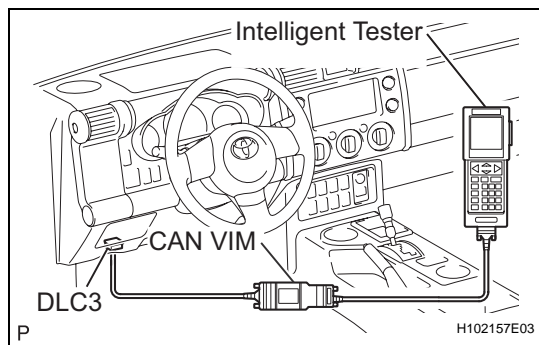

- If communication is normal when the tester is connected to another vehicle, inspect the DLC3 of the original vehicle.



- If communication is still not possible when the tester is connected to another vehicle, the problem is probably in the tester itself. Consult the Service Department listed in the tester's instruction manual.

2. DIAGNOSIS

- (a) If the skid control ECU detects a malfunction, the ABS warning light, VSC TRAC warning light, BRAKE warning light, VSC OFF indicator light and/or SLIP indicator light come on in accordance with the trouble area to warn the driver. The table below indicates which lights come on when there is a malfunction in a particular function.

<p>ABS Warning Light:</p> <p>USA: ABS</p> <p>BRAKE Warning Light:</p> 	<p>VSC TRAC Warning Light:</p> <p>Canada:  VSC TRAC</p> <p>VSC OFF Indicator Light:</p> <p>VSC OFF</p>	 <p>SLIP Indicator Light:</p> 
---	--	--

C138641E01

Indicator / Trouble Area	ABS	EBD	BA	VSC	TRAC	AUTO LSD	A-TRAC
ABS Warning Light	○	○	○	-	-	-	-
VSC TRAC Warning Light	-	-	-	○	○	○	○
Brake Warning Light	-	○	-	-	-	-	-
VSC OFF Indicator Light	-	-	-	○	-	-	-
Slip Indicator Light	-	-	-	-	○	○	○

○: Light ON, -: Light OFF

HINT:

- The DTCs are simultaneously stored in the memory. The DTCs can be read by connecting the intelligent tester.

- This system has a sensor signal check function (See page BC-28). The DTCs can be read by connecting SST (09843-18040) between terminals TS and CG of the DLC3 and observing the blinking of the ABS warning light and VSC TRAC warning light, or by connecting the intelligent tester.

3. WARNING LIGHT AND INDICATOR LIGHT CHECK

BC

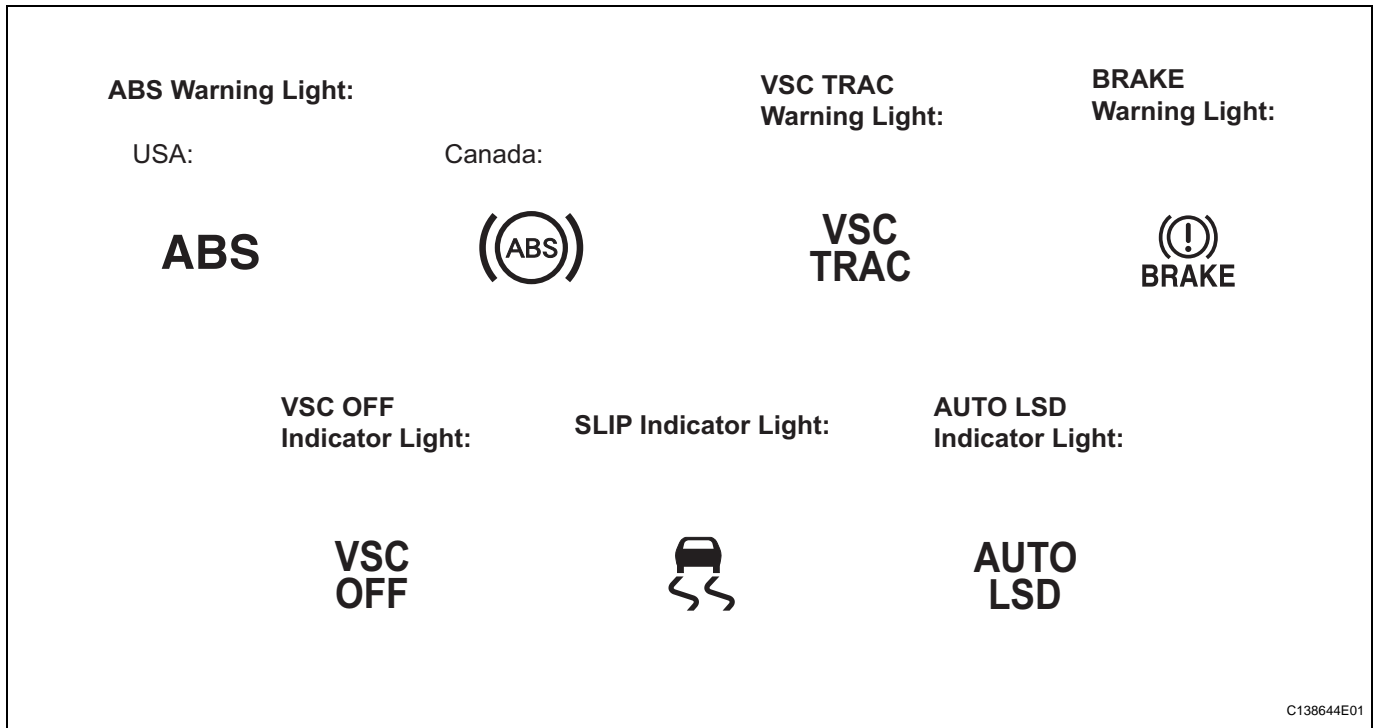

- (a) Release the parking brake.
NOTICE:
When releasing the parking brake, set chocks to hold the vehicle for safety.
HINT:
 When the parking brake is applied or the level of the brake fluid is low, the BRAKE warning light comes on.
- (b) Check that the ABS warning light, VSC TRAC warning light, BRAKE warning light, VSC OFF indicator light, SLIP indicator light and AUTO LSD indicator light come on when the ignition switch is turned on, and go off in about 3 seconds.
HINT:
 If the lights do not illuminate, confirm whether the bulbs have burned out, and also check the wire harness between the skid control ECU and the combination meter.
 If the light remains on, troubleshoot the effected light circuit by proceeding to the page indicated below.

Trouble Area	See Page
ABS warning light circuit	BC-151
VSC TRAC warning light circuit	BC-156
BRAKE warning light circuit	BC-161

Trouble Area	See Page
VSC OFF indicator light circuit	BC-168
SLIP indicator light circuit	BC-173
AUTO LSD indicator light	BC-177

BC

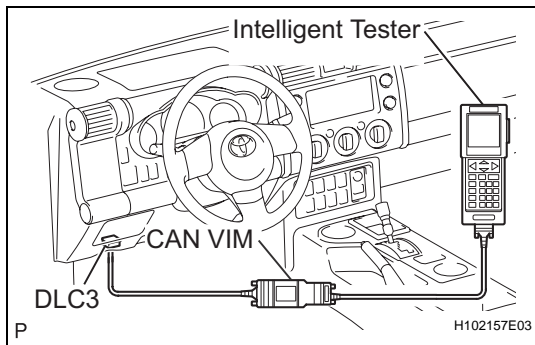

DTC CHECK / CLEAR

1. DTC CHECK (for Using a Intelligent Tester)

- (a) Check DTCs.
 - (1) Connect the intelligent tester to the DLC3.
 - (2) Turn the ignition switch on.
 - (3) Turn the tester on.
 - (4) Read the DTCs using the intelligent tester.
Select the following menu items: DIAGNOSIS / OBD/MOBD/ select vehicle / ABS/VSC / DTC INFO / TROUBLE CODES.

2. DTC CLEAR (for Using a Intelligent Tester)

- (a) Clear DTCs.
 - (1) Connect the intelligent tester to the DLC3.
 - (2) Turn the ignition switch on.
 - (3) Turn the tester on.
 - (4) Clear the DTCs using the intelligent tester.
Select the following menu items: DIAGNOSIS / OBD/MOBD/ select vehicle / ABS/VSC / DTC INFO / CLEAR CODES.

3. DTC CHECK (for Using a SST Check Wire)

- (a) Check DTCs.
 - (1) Using SST, connect terminals TC and CG of the DLC3.
SST 09843-18040
 - (2) Turn the ignition switch on.
 - (3) Read 2-digit DTCs by observing the blinking of the ABS warning light and the VSC TRAC warning light on the combination meter.

HINT:

 - If no code appears, inspect the ABS warning light circuit, VSC TRAC warning light circuit or TC and CG terminal circuit.

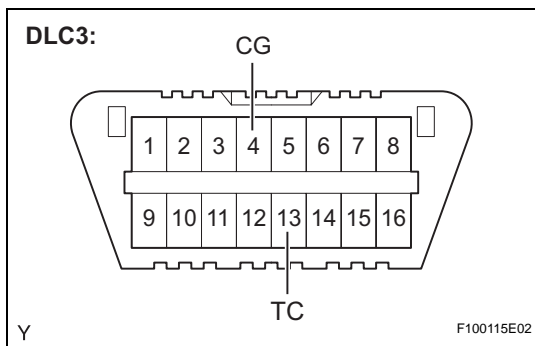

Trouble Area	See page
ABS warning light circuit	BC-151 BC-154
VSC TRAC warning light circuit	BC-156 BC-159
TC and CG terminal circuit	BC-190

- As an example, the blinking patterns of the normal system indication and DTCs 11 and 21 are shown below.

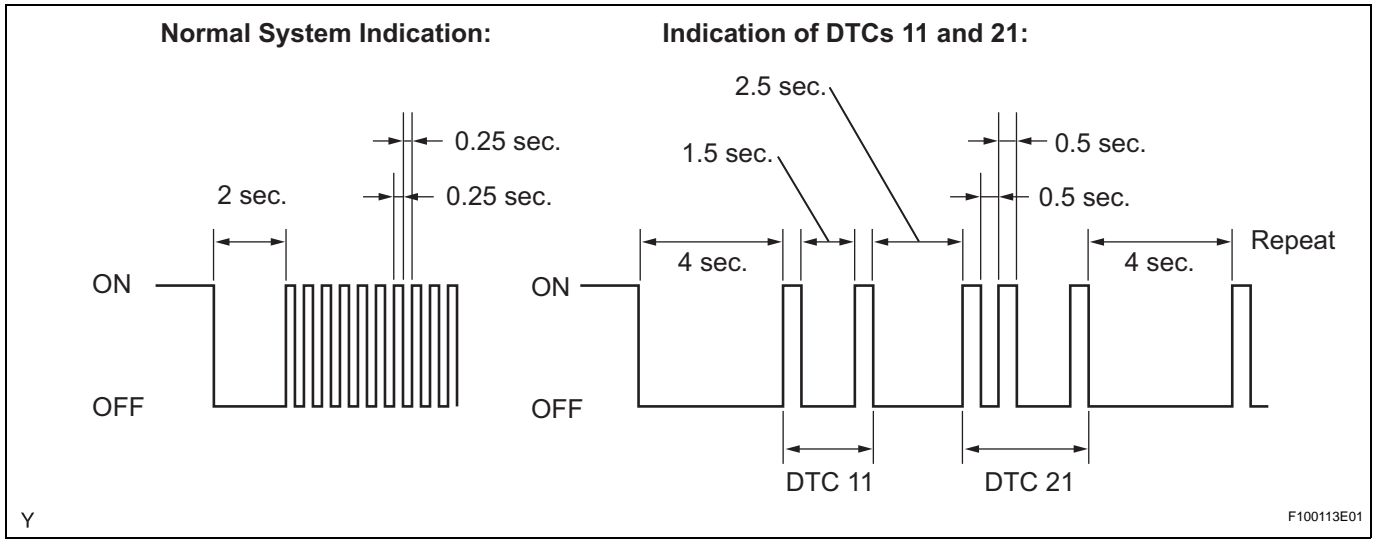

BC

- DTCs are explained in DTC chart (See page BC-53).
- (4) After completing the check, disconnect SST from terminals TC and CG of the DLC3, and turn the ignition switch off.
If 2 or more malfunctions are detected at the same time, the lowest numbered DTC is displayed first.

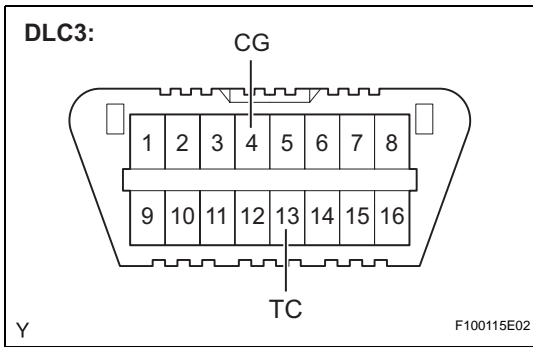

4. DTC CLEAR (for Using a Intelligent Tester)

(a) Clear DTCs.

- Using SST, connect terminals TC and CG of the DLC3.
- Turn the ignition switch on.
SST 09843-18040

- Clear the DTCs stored in the ECU by depressing the brake pedal 8 times or more within 5 seconds.
- Check that the ABS warning light and VSC TRAC warning light blink in normal code pattern.
- Remove SST from the terminals of the DLC3.
- Turn the ignition switch off.

HINT:

Clearing the DTCs cannot be performed by removing the battery cable.

5. END OF DTC CHECK/CLEAR

- Turn the ignition switch to the ON position
- Check that the ABS warning light and VSC TRAC warning light go off within approximately 3 seconds.
- Turn the ignition switch to OFF.

