

400 W. Artesia Blvd.
Compton, CA 90220
Fax: (310) 747-3912
Ph: 1-800-776-0767
E-Mail: info@procompusa.com
Website: www.procompusa.com

Latest Revision
6.3.13



off-road driven!™

PRO COMP SUSPENSION

K5074B
2007-2009
Toyota FJ 4WD
3" Lift Kit

K5075B
2005-2011
Toyota Tacoma
4WD/ 2WD Pre
Runner
3" Lift Kit
W/ Rear Add-A-Leaf

K5081B
2005-2012
Toyota Tacoma
4WD/ 2WD Pre
Runner
3" Lift Kit
W/ Rear Blocks

This document contains very important information that includes warranty information and instructions for resolving problems you may encounter. Please keep it in the vehicle as a permanent record.

K5074B FJ Kit Parts List:

Part #	Description	Qty.	Illus.	Page
57491	BOX KIT	1	-	-
57491-1	Front Coil Spring	2	1	6
91-3396	Strut Spacer	1	-	-
90-5394	Front Sway Bar Drop Bracket	2	2	7
90-6223	Hardware Pack: Sway Bar	1	-	-
70-0371251800	3/8-16 X 1 1/4" Gr. 8 Hex Bolt	4	2	7
72-037100816	3/8"-16 USS Stover Nut	4	2	7
73-03700034	3/8" SAE Gr. 8 Washer	8	2	7
90-2840	Differential Mount spacer:	2	-	-
90-6935	Hardware Pack: Diff Spacer	1	-	-
.14F150H10I	14mm-1.5 X 150mm Gr. 10.9 Hex bolt	2	-	-
.14RWFLI/HV200-125	14mm Hardened Flat Washer	4	-	-
.14FNNLZ	14mm-1.50 Nylock Nut	2	-	-
90-8076	Skid Plate Spacer	4	-	-
90-6937	Hardware Pack: Skid Plate Spacer	1	-	-
.8C40H10Z/DIN933	8mm-1.25 X 40mm Hex Bolt	4	-	-
.31RWFLZ/USS-PC	5/16" USS Flat Washer	4	-	-
57492	Rear Coil Spring	2	-	-
622053	ES6000 Front Strut	2	1	6
923553	ES9000 Rear Shock	2	-	-

OR K5075B Tacoma w/ Rear Add-A-Leaf Parts List:

57491	BOX KIT	1	-	-
57491-1	Front Coil Spring	2	1	6
91-3396	Strut Spacer	1	-	-
90-5394	Front Sway Bar Drop Bracket	2	2	7
90-6223	Hardware Pack: Sway Bar	1	-	-
70-0371251800	3/8-16 X 1 1/4" Gr. 8 Hex Bolt	4	2	7
72-037100816	3/8"-16 USS Stover Nut	4	2	7
73-03700034	3/8" SAE Gr. 8 Washer	8	2	7
90-2840	Differential Mount spacer:	2	-	-
90-6935	Hardware Pack: Diff Spacer	1	-	-
.14F150H10I	14mm-1.5 X 150mm Gr. 10.9 Hex bolt	2	-	-
.14RWFLI/HV200-125	14mm Hardened Flat Washer	4	-	-
.14FNNLZ	14mm-1.50 Nylock Nut	2	-	-
90-8076	Skid Plate Spacer	4	-	-

90-6937	Hardware Pack: Skid Plate Spacer	1	-	-
.8C40H10Z/DIN933	8mm-1.25 X 40mm Hex Bolt	4	-	-
.31RWFLZ/USS-PC	5/16" USS Flat Washer	4	-	-
622053	ES6000 Front Strut	2	1	6
925518	ES9000 Rear Shock	2	-	-
57096B-5	Rear Add-A-Leaf Box	1	-	-
13129	Add-A-Leaf	2	3	10
90-3825	Hardware Pack: Add-A-Leaf	1	-	-
98-00250-1	2 1/2" Spring Plate- Clamps	4	3	10
98-00250-1	2 1/2" Spring Plate- Straps	4	3	10
97-380	3/8" X 5" Center Bolt	2	3	10
8337-1	3/8" Fine Gr. 8 Nut	2	3	10

OR K5081B Tacoma w/ Rear Blocks Parts List:
--

57491	BOX KIT	1	-	-
57491-1	Front Coil Spring	2	1	6
91-3396	Strut Spacer	1	-	-
90-5394	Front Sway Bar Drop Bracket	2	2	7
90-6223	Hardware Pack: Sway Bar	1	-	-
70-0371251800	3/8-16 X 1 1/4" Gr. 8 Hex Bolt	4	2	7
72-037100816	3/8"-16 USS Stover Nut	4	2	7
73-03700034	3/8" SAE Gr. 8 Washer	8	2	7
90-2840	Differential Mount spacer:	2	-	-
90-6935	Hardware Pack: Diff Spacer	1	-	-
.14F150H10I	14mm-1.5 X 150mm Gr. 10.9 Hex bolt	2	-	-
.14RWFLI/HV200-125	14mm Hardened Flat Washer	4	-	-
.14FNNLZ	14mm-1.50 Nylock Nut	2	-	-
90-8076	Skid Plate Spacer	4	-	-
90-6937	Hardware Pack: Skid Plate Spacer	1	-	-
.8C40H10Z/DIN933	8mm-1.25 X 40mm Hex Bolt	4	-	-
.31RWFLZ/USS-PC	5/16" USS Flat Washer	4	-	-
58075	Block Kit: 1 1/2"	1	-	-
95-150	1 1/2" LIFT BLOCK	2	4	12
13-90126	U-BOLTS: 9/16" x 2.525" x 10.00"	4	4	12
20-65302	HARDWARE PACK: U-Bolts	1	-	-
13-30330	9/16" FLAT WASHER	8	4	12
13-10423	9/16" HIGHNUT	8	4	12
622053	ES6000 Front Strut	2	1	6
925518	ES9000 Rear Shock	2	-	-

Introduction:

- ◆ This installation requires a professional mechanic!
- ◆ We recommend that you have access to a factory service manual for your vehicle to assist in the disassembly and reassembly of your vehicle. It contains a wealth of detailed information.
- ◆ Prior to installation, carefully inspect the vehicle's steering and driveline systems paying close attention to the tie rod ends, ball joints, wheel bearing preload, pitman and idler arm. Additionally, check steering-to-frame and suspension-to-frame attaching points for stress cracks. The overall vehicle must be in excellent working condition. Repair or replace all worn or damaged parts!
- ◆ Read the instructions carefully and study the illustrations before attempting installation! You may save yourself a lot of extra work.
- ◆ Check the parts and hardware against the parts list to assure that your kit is complete. Separating parts according to the areas where they will be used and placing the hardware with the brackets before you begin will save installation time.
- ◆ Check the special equipment list and ensure the availability of these tools.
- ◆ Secure and properly block vehicle prior to beginning installation.
- ◆ ALWAYS wear safety glasses when using power tools or working under the vehicle!
- ◆ Use caution when cutting is required under the vehicle. The factory undercoating is flammable. Take appropriate precautions. Have a fire extinguisher close at hand.
- ◆ Foot pound torque readings are listed on the Torque Specifications chart at the end of the instructions. These are to be used unless specifically directed otherwise. Apply thread lock retaining compound where specified.
- ◆ **Please note that while every effort is made to ensure that the installation of your Pro Comp lift kit is a positive experience, variations in construction and assembly in the vehicle manufacturing process will virtually ensure that some parts may seem difficult to install. Additionally, the current trend in manufacturing of vehicles results in a frame that is highly flexible and may shift slightly on disassembly prior to installation. The use of pry bars and tapered punches for alignment is considered normal and usually does not indicate a faulty product. However, if you are uncertain about some aspect of the installation process, please feel free to call our tech support department at the number listed on the cover page. We do not recommend that you modify the Pro Comp parts in any way as this will void any warranty expressed or implied by the Pro Comp Suspension company.**

Optional Equipment Available from your Pro Comp Distributor!

Tacoma:

4WD/2WD Pre Runner Suspension Lift Kit: 2005-2011 Non VSC 57096/57096MX or 2005-2012 w/ VSC 57396/57396MX

Coil Over Upgrade Kit: 57097/57097MX*

Traction Bars: 72500B*

Mounting kit: 72083B*

Skid Plate: 57196*

Light Bar: 25000

CV Style Driveshaft: 57098*

**To be used in conjunction with Pro Comp 6" lift kits*

FJ:

4WD & 2WD Suspension Lift Kit: 57007/57007MX

Coil Over Upgrade Kit: 57008MX

Also, Check out our outstanding selection of Pro Comp tires to compliment your new installation!

Important!

Tire and wheel choice is crucial in assuring proper fit, performance, and the safety of your Pro Comp equipped vehicle. For this application, we recommend a 17" X 8" non hub-centric wheel with a maximum backspacing of 4 1/2" (PN 8089-7883). Additionally, a quality tire of radial design, not exceeding 33" tall X 12.5" wide tire (PN 27033) is recommended. Installation of larger wheels may be possible, but must not exceed 5" of backspacing. Be sure to check fit all wheel and tire combinations before purchasing and installation. Violation of these recommendations will not be endorsed as acceptable by Pro Comp Suspension and will void any and all warranties either written or implied.

Please Note:

- * Front suspension and head light realignment is necessary!
- * Speedometer and ABS recalibration will be necessary if larger tires (10% more than stock diameter) are installed.
- * Always use NEW cotter pins on re-assembly! (These items are NOT supplied)
- * **IT IS ADVISABLE THAT YOU HAVE HELP AVAILABLE WHEN INSTALLING THIS KIT. SOME COMPONENTS ARE HEAVY AND AWKWARD. ADDITIONAL HELP IS GOOD INSURANCE AGAINST INJURY!**

NOTE: The final height of this kit is dependant upon the engine, transmission and body configurations.

Special Tools:

Please refer to your service manual for more information.
A special removal tool is required for safe removal of the tie rods.
These tools may be purchased at your local Toyota dealer.
You may be able to rent any of these tools at your local parts store.

FJ & TACOMA KIT FRONT INSTALLATION:

1. Prior to installing this kit, with the vehicle on the ground. Measure the height of your vehicle. This measurement can be recorded from the center of the wheel, straight up to the top of the inner fender lip. Record the measurements below.

LF: _____ RF: _____

LR: _____ RR: _____

2. Ensure that your work space is of adequate size and the work surface is level. Place the vehicle in park. Place your floor jack under the front cross member and raise vehicle. Place jack stands under the frame rails behind the front wheel wells and lower the frame onto the stands. Remove the jack and place the vehicle back in gear, set the emergency brake, and place blocks both in front of and behind the rear wheels.
3. Remove the front wheels. Save the hardware for reinstallation. Save the hardware for reinstallation.
4. Remove the front skid plate and mid plate, if applicable.
5. Disconnect the ABS lines.
6. Disconnect the sway bar end links and remove the lower ball joint cotter pin and nut.
7. Loosen but do not remove the lower a-arm bolts to allow the lower control arm to pivot on the bushings.
8. Remove the (2) bolts from the lower ball joint bracket. Save bolts for reinstallation.
9. Remove the lower strut bolt from the lower control arm and remove the strut assembly from the vehicle.

NOTE: the direction of the bolt for reinstallation

10. Remove upper strut tower nuts holding

the strut assembly to the strut tower (3) on each side of the vehicle. Save for reinstallation.

11. Scribe an index mark on the top of the OE coil spring to the upper strut mounting plate.

CAUTION: The coil is under extreme pressure and severe bodily injury may occur if the coil spring is disassembled without using a coil spring compressor.

12. Compress the coil spring on the strut assembly with a suitable coil spring compressor so that the coil spring has about 3/8" play in the strut and remove the upper strut isolator retaining nut.

NOTE: Do not use an impact gun to remove the retaining nut. It will damage the strut shaft.

13. Remove the OE coil spring isolator from the upper strut mounting plate. See ILLUSTRATION 1.

IMPORTANT!: Be sure that the factory isolator stays with the top mount assembly.

NOTE: Inspect the front shock assemblies for any damage or fluid leakage. Replace if necessary.

14. Install the new compressed coil spring (57491) and OE isolator onto the new strut assembly (622053) and re-attach the upper strut mount plate using the stock hardware. Torque the upper strut mounting plate retaining nut to 20 ft./lbs. See ILLUSTRATION 1.

15. Decompress the coil spring on the strut assembly. Make sure that the spring is seated correctly into the strut assembly and aligned with the previously scribed index mark on the upper strut mounting plate. See ILLUSTRATION 1.

16. Install the lower strut bolt in the original position and torque to 100 ft./lbs. for the FJ and 61 ft./lbs. for the Tacoma.

17. ***ON THE DRIVER SIDE ONLY***, install the coil spacer (91-3396) onto the driver side upper strut mount studs. See ILLUSTRATION 1.
18. Install the strut assembly into the strut tower and start the upper three OE nuts. (Make sure that the bottom of the strut is aligned as well). See ILLUSTRATION 1.
19. Using the floor jack, raise the lower control arm and connect the lower ball joint bracket to the knuckle using the (2) previously removed OE bolts. Apply thread locking compound to the bolts. Torque

the bolts to 118 ft./lbs.

20. Unbolt the sway bar frame mount brackets. Save the OE hardware for reuse.
21. Carefully cut the OE collars off the sway bar using a cutting wheel or another suitable tool.

NOTE: *Be very careful not to cut into the sway bar.*

22. Install the sway bar drop brackets (90-5394) to the original sway bar mounting holes in the frame, with the protruding rounded portion on the outside facing the rear of the vehicle. Secure to the frame using the OE bolts. Torque to 30 ft./lbs.

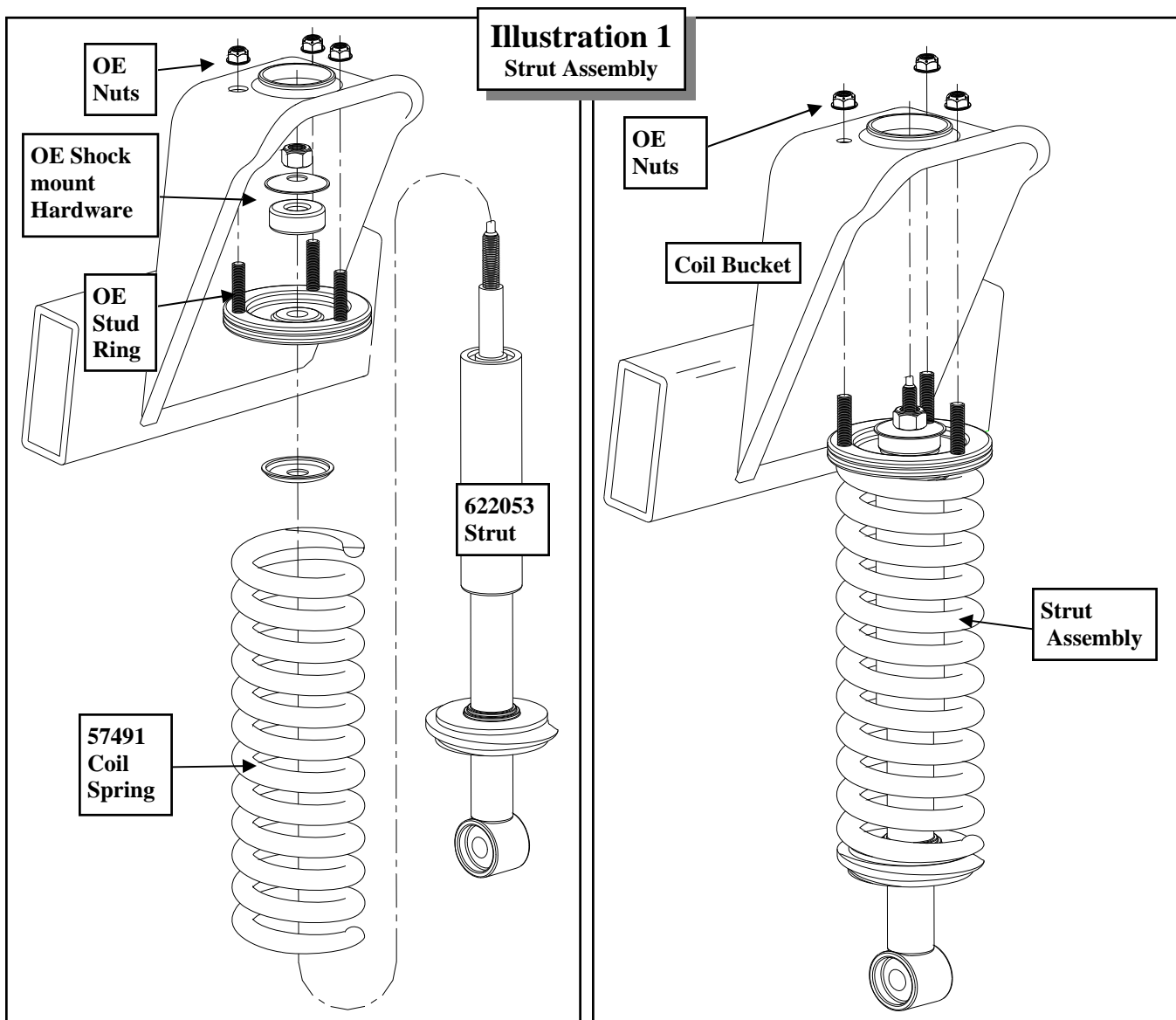

See ILLUSTRATION 2.

23. Reinstall the sway bar to the new sway bar drop brackets using the supplied **3/8" X 1 1/4"** bolts and hardware. Torque the **3/8"** bolts according to the chart on page 13. See ILLUSTRATION 2.
24. Reconnect the sway bar end links using the previously removed **OE** hardware. Torque the nut to **52** ft./lbs.
25. Carefully position a floor jack under the front differential and raise the pad to contact the differential.
26. Remove the **OE** differential mounting nuts and bolts.
27. Install the differential mount spacers (**90-2840**) between the differential mounts and the front crossmember. Secure the diff mount using the supplied **14mm X 150mm** bolts, large **14mm** washer and **14mm** hardware. Torque per specifications in the chart on page 7.
28. Reconnect the ABS lines.
29. Reinstall the front skid plate, if applicable, using **OE** hardware in the front holes and the (2) supplied spacers (**90-8076**) and (2) **8mm X 40mm** bolts and **5/16"** washers in the rear holes..
30. Reinstall the mid plate, if applicable, using the (2) supplied spacers (**90-8076**) and

(2) **8mm X 40mm** bolts and **5/16"** washers in the front holes and the **OE** hardware in the rear holes.

31. Reinstall the front wheels. Reinstall the wheels and lower the vehicle to the ground. Torque the lug nuts according to the wheel manufacturers recommendations.

NOTE: Trimming of the wheel well liner on the backside of the fender well may be necessary depending on the tire/wheel combination.

32. Lower the vehicle onto the ground and tighten the upper strut tower **OE** nuts to **47** ft./lbs.
33. With the vehicle on the ground, torque the lower A-arm cam bolts to **100** ft./lbs.
34. Recheck all hardware for proper installation and torque at this time.

IMPORTANT! BE SURE TO BRING THE VEHICLE TO A REPUTABLE ALIGNMENT SHOP TO BE ALIGNED!

IMPORTANT!: IF THE STEERING WHEEL IS NOT CENTERED PROPERLY IT WILL TRIGGER THE ANTI-LOCK BRAKE AND TRACTION CONTROL WARNING LIGHTS.

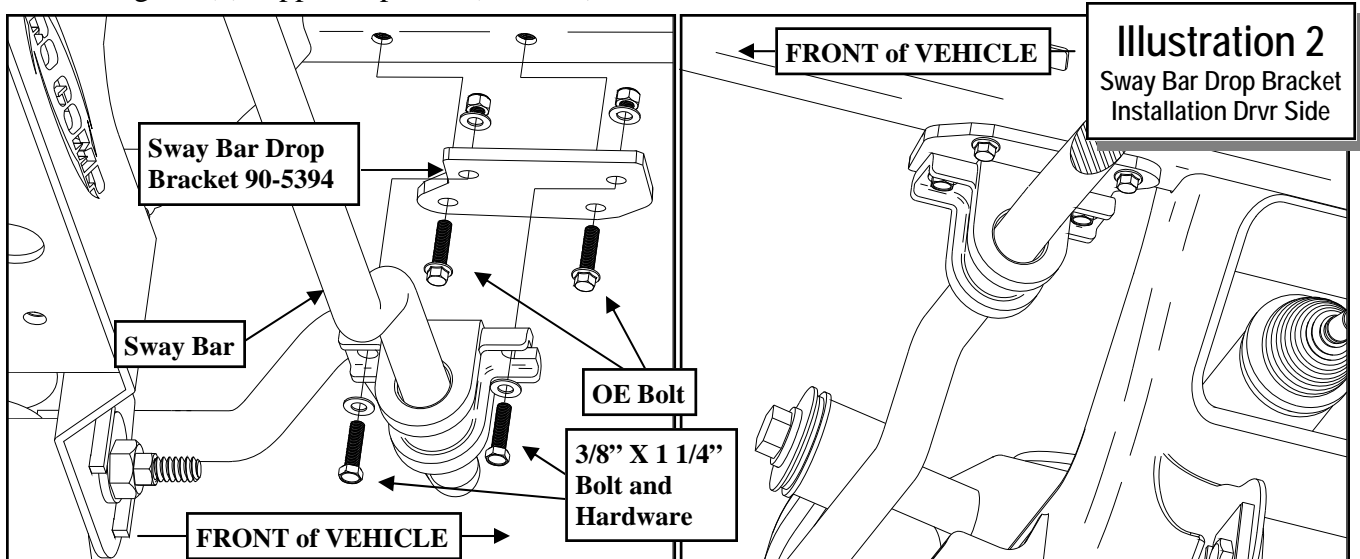

FJ REAR INSTALLATION

1. Block the front tires and raise the rear of the vehicle. Support the frame with jack stands forward of the rear springs.
2. Remove the rear wheels.
3. Remove the shocks on both sides of the vehicle. It may be necessary to slightly raise the axle to unload the shocks for removal.
4. Lower the rear axle enough to remove the coil springs from the front spring pockets. Save the factory isolators for re-use.
11. Repeat the installation on the other side of the vehicle.
12. Check all hardware at this time to ensure that everything is tight. Check for adequate clearance on all repositioned brake lines and emergency brake cables. Make sure you check with the suspension fully extended, and compressed.
13. Reinstall the wheels and lower the vehicle to the ground. Torque the lug nuts according to the wheel manufacturers recommendations.

NOTE: Be sure to support the axle while the springs and shocks are removed.

5. Unbolt the track bar from the rear axle mount and secure up and out of the work area. Save the hardware for reinstallation.
6. Unbolt the sway bar end links from the sway bar. Save the hardware for reuse.
7. On both sides of the vehicle support the rear end with a jack and unbolt the lower control arm at the axle.
8. Carefully lower the rear end to ease in the new coil spring installation. Using the factory isolators install the Pro Comp coil springs (**57492**) into the spring buckets and raise the rear axle into place. Make sure the coil spring seats properly on the lower spring perch.
9. Install your new Pro Comp shocks (**923553 w/shaft end up**) to the **OE** shock mounts. Torque the upper mounting hardware to **18** ft./lbs. and the lower **OE** mounting bolt to **72** ft./lbs.

IMPORTANT!: *Install one of the supplied 3/4" flat washers onto the mounting stud before and after the shock is installed to the mounting stud.*

10. Reattach the sway bar end links to the sway bar using the previously removed **OE** hardware. Torque the nut to **52** ft./lbs.

14. With the vehicle on the ground reinstall the track bar to the rear axle using the previously removed **OE** hardware. Torque the **OE** hardware to **96** ft./lbs.

NOTES:

- ⇒ **On completion of the installation, have the suspension and headlights re-aligned.**
- ⇒ **After 100 miles recheck for proper torque on all newly installed hardware.**
- ⇒ **Recheck all hardware for tightness after off road use.**

TACOMA REAR ADD-A-LEAF KIT INSTALLATION:

NOTE: *In order to properly install the add-a-leaf spring, it will be necessary to contain the elasticity in the leaf spring with “C” clamps when the center bolts are removed. Some springs have a factory helper spring consisting of one or more flat leaves installed at the bottom of the leaf pack. DO NOT install the add-a-leaf spring in or below the helper spring.*

1. Block the front tires and raise the rear of the vehicle. Support the frame with jack stands forward of the rear springs.
2. Remove the rear wheels.
3. Remove the shocks on both sides of the vehicle. It may be necessary to slightly raise the axle to unload the shocks for removal.
4. Work on one side of the vehicle at a time.
5. Support the rear axle with a floor jack and remove the **U-bolts** on the driver side. Loosen the **U-bolts** on the passenger side and lower the rear axle.

NOTE: *Be sure not to over extend the rear brake lines.*

6. Use C-clamps to hold the leaves of the rear leaf spring together and remove spring center bolt.
7. Disassemble the leaf spring and insert the add-a-leaf (**13129**). See ILLUSTRATION 3.

NOTE: *Add-a-leaf will be placed in the spring assembly progressively according to length. For example, if the existing leaves are 32” long and 25” long and the add-a-leaf is 28” long, place the add-a-leaf between the existing leaves.*

8. Using the C-clamps, re-clamp and bolt the leaf pack back together using the supplied center bolt (**97-380**) with the head of the bolt facing down. See ILLUSTRATION 3.

9. Install the lift block (*If the vehicle is equipped with one*), making sure the pins fit properly into the holes on the spring perch. Use your floor jack to raise the axle to the spring. Make sure the pin on the leaf spring fit into the holes on the new lift block. See ILLUSTRATION 3.

NOTE: *These blocks are slightly tapered and the short side of the taper is oriented to the front of the vehicle.*

10. Secure the assembly with the **U-bolts** and high-nuts and washers. Do not torque the **U-bolts** at this time. See ILLUSTRATION 3.

NOTE: *Make sure the block sits flush on the axle perch.*

11. Repeat the installation on the other side of the vehicle.
12. When the installation of the remaining side is complete, torque the **U-bolts** to **85** ft./lbs.
13. Install your new Pro Comp shocks (**925518 w/shaft end up**) to the **OE** shock mounts. Torque the upper mounting hardware to **18** ft./lbs. and the lower **OE** mounting bolt to **72** ft./lbs.
14. Reinstall the wheels and tires and lower the vehicle to the ground. Torque the wheels to the manufacturers recommended specifications.
15. Recheck the wheel lug torque on all four wheels at this time.
16. Recheck all hardware for proper installation and torque at this time.
17. On completion of the installation, have the suspension and headlights re-aligned.
18. After 100 miles recheck for proper torque on all newly installed hardware.
19. Recheck all hardware for tightness after off road use.

NOTES:

- ⇒ On completion of the installation, have the suspension and headlights re-aligned.
- ⇒ After 100 miles recheck for proper torque on all newly installed hardware.
- ⇒ Recheck all hardware for tightness after off road use.

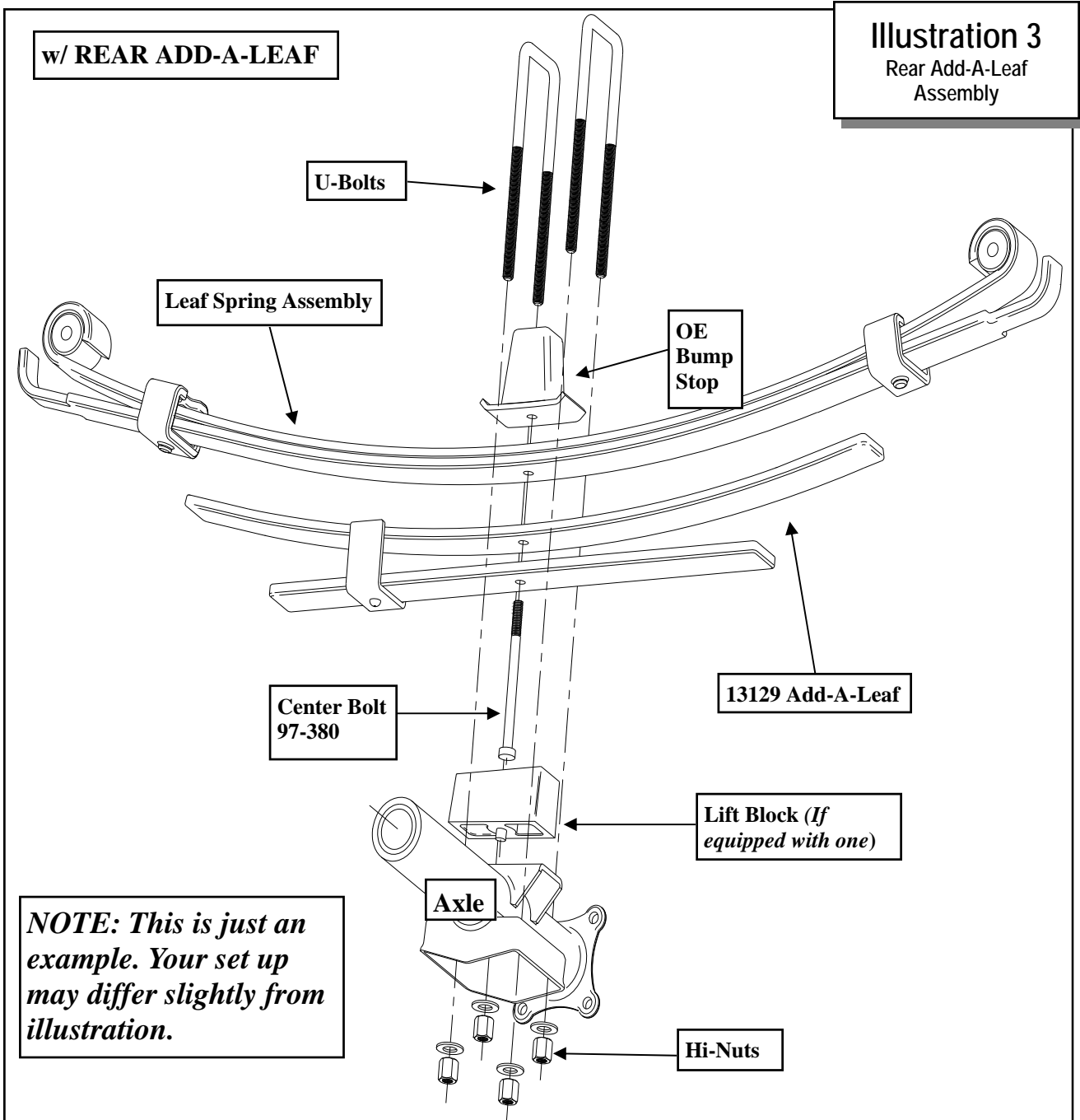

TACOMA REAR BLOCK KIT INSTALLATION:

1. Block the front tires and raise the rear of the vehicle. Support the frame with jack stands forward of the rear springs.
2. Remove the rear wheels.
3. Remove the shocks on both sides of the vehicle. It may be necessary to slightly raise the axle to unload the shocks for removal.
4. Work on one side of the vehicle at a time.
5. Support the rear axle with a floor jack and remove the **U-bolts** on the driver side. Loosen the **U-bolts** on the passenger side and lower the rear axle.

NOTE: *Be sure not to over extend the rear brake lines.*

6. Install the lift block (**95-150**) making sure the pins fit properly into the holes on the spring perch. Use your floor jack to raise the axle to the spring. Make sure the pin on the leaf spring fit into the holes on the new lift block. See ILLUSTRATION 4.
7. Secure the assembly with the **U-bolts (13-90126)** and high-nuts and washers (**20-65302**). Do not torque the **U-bolts** at this time. See ILLUSTRATION 4.

NOTE: *Make sure the block sits flush on the axle perch.*

8. Repeat the installation on the other side of the vehicle.
9. When the installation of the remaining side is complete, torque the **U-bolts** to **85** ft./lbs.
10. Install your new Pro Comp shocks (**925518 w/shaft end up**) to the **OE** shock mounts. Torque the upper mounting hardware to **18** ft./lbs. and the lower **OE** mounting bolt to **72** ft./lbs.
11. Reinstall the wheels and tires and lower the vehicle to the ground. Torque the

wheels to the manufacturers recommended specifications.

12. Recheck the wheel lug torque on all four wheels at this time.
13. Recheck all hardware for proper installation and torque at this time.
14. On completion of the installation, have the suspension and headlights re-aligned.
15. After 100 miles recheck for proper torque on all newly installed hardware.
16. Recheck all hardware for tightness after off road use.





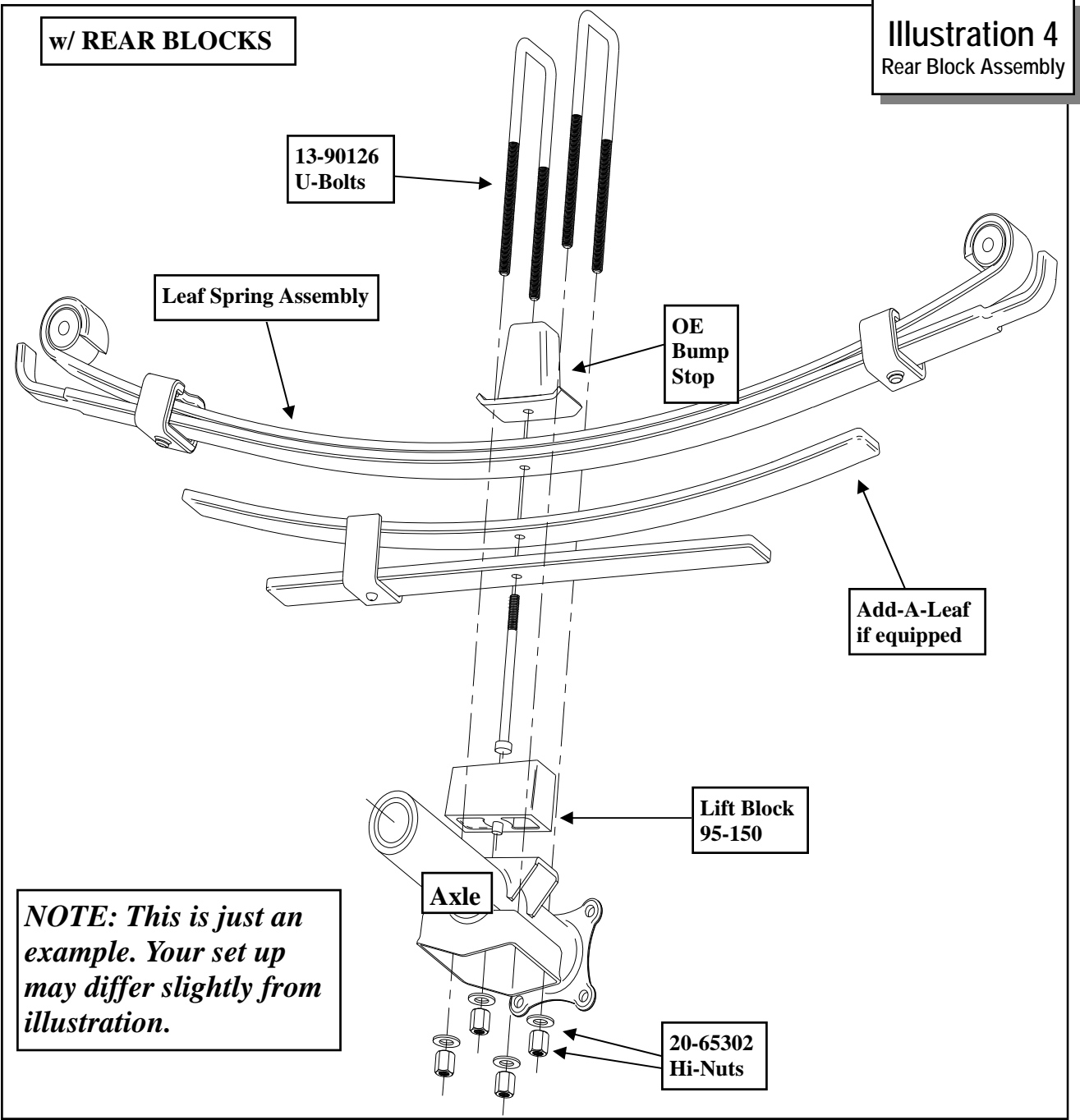

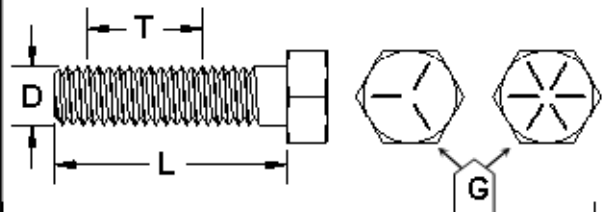
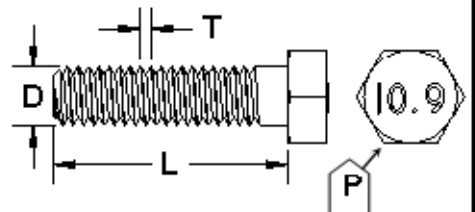

NOTES:

- ⇒ **On completion of the installation, have the suspension and headlights re-aligned.**
- ⇒ **After 100 miles recheck for proper torque on all newly installed hardware.**
- ⇒ **Recheck all hardware for tightness after off road use.**



Use this only as a guide for hardware without a called out torque specification in the instruction manual.

Bolt Torque and ID						
Decimal System			Metric System			
All Torques in Ft. Lbs. Maximums						
Bolt Size	Grade 5	Grade 8	Bolt Size	Class 9.8	Class 10.9	Class 12.9
5/16	15	20	M6	5	9	12
3/8	30	45	M8	18	23	27
7/16	45	60	M10	32	45	50
1/2	65	90	M12	55	75	90
9/16	95	130	M14	85	120	145
5/8	135	175	M16	130	165	210
3/4	185	280	M18	170	240	290

	
<p>1/2-13x 1.75 HHCS Grade 5 Grade 8</p> <p>(No. of Marks + 2)</p> <p>   </p>	<p>M12-1.25x50 HHCS</p> <p>   </p>
<p>G = Grade (Bolt Strength)</p> <p>D = Nominal Diameter (Inches)</p> <p>T = Thread Count (Threads per Inch)</p> <p>L = Length (Inches)</p> <p>X = Description (Hex Head Cap Screw)</p>	<p>P = Property Class (Bolt Strength)</p> <p>D = Nominal Diameter (Millimeters)</p> <p>T = Thread Pitch (Thread Width, mm)</p> <p>L = Length (Millimeters)</p> <p>X = Description (Hex Head Cap Screw)</p>

Revisions Page:

10.6.11: Updated manual fitment years. Added K5081 to cover and BOM pages. Added K5081 rear block kit installation text and illustration #4.

5.28.13: Added diff spacer 90-2840, 90-8076, hardware packs 90-6935, and 90-6937 to the BOM and the text. Updated cover logo, warranty page, and contact information.



The PRO COMP PROMISE WARRANTY

At Pro Comp, we know you have many choices when selecting products to personalize your vehicle. You should demand nothing but the highest quality available and have total confidence that the products you selected are the best in the industry. It is for these reasons that Pro Comp Suspension products are backed by the best warranty in the industry...the Pro Comp Promise!

Pro Comp promises that its products will last a lifetime or we will replace it free of charge. It's that simple! Because of our commitment to quality and manufacturing excellence, we are able to stand behind our products. FOREVER. It is Pro Comp's Promise that if one of our suspension products breaks not due to misuse, neglect or vandalism, we will replace it. Whether you are the original purchaser or not, you can be assured that we will make it right. The Pro Comp Promise covers all suspension products including shocks and steering stabilizers. Buy Pro Comp Suspension today and enjoy it for the rest of your life!

That's our Pro Comp Promise!

Notice to Owner, Operator, Dealer and Installer:

Vehicles that have been enhanced for off-road performance often have unique handling characteristics due to the higher center of gravity and larger tires. This vehicle may handle, react and stop differently than many passenger cars or unmodified vehicles, both on and off-road. You must drive your vehicle safely! Extreme care should always be taken to prevent vehicle rollover or loss of control, which can result in serious injury or even death. Always avoid sudden sharp turns or abrupt maneuvers and allow more time and distance for braking! Pro Comp reminds you to fasten your seat belts at all times and reduce speed! We will gladly answer any questions concerning the design, function, maintenance and correct use of our products.

Please make sure that the Dealer / Installer explains and delivers all warning notices, warranty forms and instruction sheets included with Pro Comp product.

Warranty and Return Policy:

Pro Comp warrants its full line of products to be free from defects in workmanship and materials for the life of the product. Pro Comp's obligation under this warranty is limited to repair or replacement, at Pro Comp's option, of the defective product. Any and all costs of removal, installation, freight or incidental or consequential damages are expressly excluded from this warranty. Pro Comp is not responsible for damages and / or warranty of other vehicle parts related or non-related to the installation of Pro Comp product. A consumer who makes the decision to modify his vehicle with aftermarket components of any kind will assume all risk and responsibility for potential damages incurred as a result of their chosen modifications. Warranty coverage does not include consumer opinions regarding ride comfort, fitment and design. Warranty claims can be made directly with Pro Comp or at any factory authorized Pro Comp dealer.

IMPORTANT! To validate the warranty on this purchase please be sure to mail in the warranty card.

Claims not covered under warranty

* Parts subject to normal wear; this includes bushings, bump stops, ball joints, tie rod ends and heim joints.

* Finish after 90 days.

* Damage caused as a result of not following recommendations or requirements called out in the installation manuals.

Pro Comp MX Series coil-over shocks are considered a serviceable shock with a one-year warranty against leakage only. Rebuild service and replacement parts will be available and sold separately by Pro Comp. Contact Pro Comp for specific service charges. Pro Comp accepts no responsibility for any altered product, improper installation, lack of or improper maintenance or improper use of our products.

E-Mail: info@procompusa.com
Website: www.procompusa.com
Fax: (310) 747-3912
Ph: 1-800-776-0767

PLACE
WARRANTY REGISTRATION
NUMBER
HERE: _____